

FSI VIEWER

Let your website visitors have a closer look

User Manual



FSI Viewer
FSI TouchZoom
FSI QuickZoom
FSI ThumbBar
FSI Showcase
FSI Pages
FSI ImageGrid
FSI ImageTwins Game

Last update: January 2020

Latest Build: 20.01

Developed by:
NeptuneLabs GmbH
Lagesche Str. 32
D-32657 Lemgo
Germany

© 2009-2020 NeptuneLabs. All rights reserved.

All brands and product names are trademarks or registered trademarks of the respective producers. FSI Viewer, FSI Server and NeptuneLabs are registered trademarks of NeptuneLabs GmbH, Germany.

1	Introduction	10
2	FSI Viewer	11
2.1	Usage	11
2.2	How it works.....	14
2.3	Using FSI Viewer	15
2.3.1	The Menu Bar	16
	Main Functions.....	16
2.3.2	Mouse Modes.....	17
2.3.3	Additional Buttons.....	18
2.3.4	Using the navigator window	19
2.4	Index structure of FSI Viewer.....	19
2.5	Configuration	20
2.5.1	Enabling the Debug Mode.....	20
2.5.2	Using XML Configuration Files (*.xml).....	21
2.5.3	Hierarchy of Configuration Parameters.....	26
	Configuration Hierarchy.....	27
	Choosing the adequate Configuration Method	27
2.5.4	Conditional Configuration Options.....	28
	Cascaded Conditions	30
	Conditions and Groups	30
	Building Conditions	32
2.5.5	Retrieving Parameters from FSI Server	35
2.5.6	Using Custom Language Files.....	36

2.6	Parameters.....	38
2.6.1	Basic Parameters.....	42
	General.....	42
	Display Options.....	63
	Preview Options.....	71
	Global Parameters for Hot Spots	74
	Camera Section.....	78
	VirtualSpace Section.....	87
	HotSpot Section.....	91
	Video Section.....	107
2.6.2	Plugin Parameters	112
	Resize Plug-In	113
	MaxZoom Plug-In	114
	ZoomMeter Plug-In.....	114
	AutoSpin Plug-In.....	116
2.7	Creating and using Spin Videos	128
2.8	Embedding the viewer at runtime.....	129
2.9	JavaScript Interface	133
2.9.1	Public Methods	133
2.9.2	Callbacks	150
	Using Callbacks.....	151
3	FSI TouchZoom	165
3.1	Usage	165

3.2	Initializing FSI TouchZoom	167
3.3	Parameters.....	169
3.4	JavaScript Interface	176
3.4.1	Public Methods	177
3.4.2	Callbacks	184
4	FSI QuickZoom.....	186
4.1	Usage	186
4.2	How FSI QuickZoom works	188
4.3	Parameters.....	189
4.3.1	Defining box-shadow and fade-in.....	200
4.4	Initializing FSI QuickZoom manually.....	201
4.5	JavaScript Interface	203
4.5.1	Public Methods	204
4.5.2	Callbacks	209
5	FSI Pages	212
5.1	Introduction	212
5.2	How FSI Pages works.....	212
5.3	Usage of FSI Pages	213
5.3.1	Defining Image Collections	217
5.3.2	Aspect Ratio of the Pages	220
5.3.3	Presets in FSI Server Interface	220
5.3.4	Printing Pages.....	220
5.3.5	Saving Pages	222

	Saving a complete PDF	223
5.3.6	Special URL Values	224
5.3.7	Creating Intro Content	225
5.4	Parameters.....	227
5.4.1	General Parameters	230
	Search	248
5.4.2	Layout/Appearance Parameters.....	254
5.4.3	Link Parameters.....	270
5.4.4	Plug-in Parameters	276
	FullScreen.....	277
	PagesThumbBar	277
	Bookmarks.....	279
	Chapters.....	281
5.5	JavaScript Interface	283
5.5.1	Public Methods	283
5.5.2	Callbacks	297
6	FSI ThumbBar.....	309
6.1	Usage	309
6.2	How FSI ThumbBar works.....	312
6.3	Parameters.....	313
6.4	Customization.....	339
6.4.1	CSS Classes	339
6.4.2	Adding Control Buttons.....	339

6.4.3	Defining a custom presentation type	341
6.5	JavaScript Interface	343
6.5.1	Public Methods	343
6.5.2	Callback functions	351
7	FSI Showcase	356
7.1	Usage	356
7.2	Configuration	359
7.2.1	Defining Image Lists.....	359
7.2.2	Filtering Image Lists.....	362
7.2.3	Using Labels in FSI ThumbBar	363
	Defining labels.....	363
	Label Values.....	365
8	FSI Image Grid	368
8.1	Usage	368
8.2	Parameters.....	369
8.3	JavaScript Interface	378
8.3.1	Public Methods	378
8.3.2	Callback functions.....	383
9	FSI Image Twins Game	386
9.1	Usage	386
9.2	Parameters.....	387
9.3	JavaScript Interface	394
9.3.1	Public Methods	394

9.3.2	Callback functions	398
10	Appendix	402
10.1	Escaping or URL-encoding parameter values	402
10.2	HTML Tags available in FSI Viewer	402
10.3	Example of a custom skin CSS file	403
11	Index	409

I Introduction

The JavaScript based viewers FSI Viewer, FSI TouchZoom, FSI QuickZoom, FSI Showcase, FSI Pages and FSI ThumbBar bring outstanding zoom and viewer qualities to almost all devices. They are highly customizable and work independently from FSI Viewer Flash.

FSI Server is the basis of all viewers which request the image data from it. By using FSI Server, only one high resolution source image is required for each image to be displayed.

Thank you for using NeptuneLabs software!

www.neptunelabs.com : **Online Resources for FSI Viewer**

Visit www.neptunelabs.com for software updates, regularly updated samples, tutorials and downloads.

2 FSI Viewer

FSI Viewer is a JavaScript based tool to display 2D image zoom and 360° Object spins on desktop computers and mobile devices. Depending on the device capabilities it offers in place zoom or pinch zoom support. FSI Viewer also supports optional multiple axis spin.

Using an optional video, the rotation of the 360° object can be displayed extremely smooth on devices that support video capturing.

Optional hot spots with HTML content can be added by providing 3D coordinates (x,y,z) in millimeters.

Imaging Servers

FSI products covered by this manual can at present securely be run with FSI Server from version 2016.

Supported devices

- iOS 4 or higher
- Android 4.x based devices
- Windows Phone 8 and Windows RT devices
- Windows 8 with touch enabled browsers
- Mouse zoom: desktop or laptop computers & all major browsers

2.1 Usage

1) Add the fsiviewer.js script to the head of your document:

Adding the script:

```

<head>
[...]
//adding the fsiviewer.js script
<script src="viewer/applications/viewer/js/fsiviewer.js"
  type="text/javascript"></script>
</head>

```

II) Add a `<fsi-viewer>` tag to the part of your document body where the zoom and/or the 360° product spin should be displayed. Add the desired dimension and the `imagesource` directory to it:

Integrate FSI Viewer JS (2D Zoom):

```

<body>
[...]
<fsi-viewer width="500" height="600" src="/images/
foo.tiff">
// here you can place the fallback content in case the
browser
// cannot display the viewer, e.g,:
<!-- Fallback Content -->
<b>Sorry</b>, your browser is not capable of running FSI
Viewer JS.
</fsi-viewer>
</body>

```

Integrate FSI Viewer JS 360 (360° Spins):

```
<body>
[...]  
<fsi-viewer width="500" height="600" dir="/images/  
spin/">  
// here you can place the fallback content in case the  
browser  
// cannot display the viewer, e.g.,:  
<!-- Fallback Content -->  
<b>Sorry</b>, your browser is not capable of running FSI  
Viewer JS.  
</fsi-viewer>  
</body>
```

Parameters are added to the `<fsi-viewer>` tag. Note that you can as well use FSI Viewer configuration files (required e.g. when using hot spots):

Adding Parameters to the viewer:

```
<head>
//adding the fsiviewer.js script
<script src="js/fsiviewer.js" type="text/javascript"></
script>
</head>

<body>

//Adding parameters directly to the tag:
<fsi-viewer width="500" height="600" src="/images/
sample.jpg"
debug="true" skin="silver">
</fsi-viewer>

//Example with using a FSI Viewer configuration file:
<fsi-viewer width="500" height="600" src="/images/
sample.jpg"
cfg="sample/sample_configuration">
</fsi-viewer>

</body>
```

2.2 How it works

The script uses the given `<fsi-viewer>` tag, which is similar to an `` tag, to display a single image zoom and/or 360° object spin.

If a video has been defined, the script captures video frames on start to provide an ultra smooth rotation.

Without a video (or on devices not supporting video capturing) a fixed number of images from different viewing angles will be used to display the object spin.

The user can drag the image left and right to spin and zoom in/out either using pinch zoom or by clicking on the object.

⚠ Note on Internet Explorer:

In order to make FSI Viewer JS work, Internet Explorer must run in IE8 quirks, IE9 or higher quirks or standards mode. You can ensure that by adding an X-UA-Compatible meta tag to the head section of your web page, for example:

```
<meta http-equiv="X-UA-Compatible" content="IE=Edge">
```

The HTML code generated in the FSI Server interface contains all necessary tags to ensure maximum compatibility on all devices.

2.3 Using FSI Viewer

FSI Viewer is navigated by the menu bar (here seen below the image) and by using the mouse directly on the image. For example, you can select a section of the image you want to magnify.

The mouse functions are determined by the corresponding buttons on the menu bar (zoom, pan, rotate, etc.).

The optional small navigator window (bottom right) displays the position of the image section currently viewed.





2.3.1 The Menu Bar





 The menu bar might look different depending on skins or additional plugins.



Main Functions

	<p>Back to Initial View.</p> <p>Undoes zoom, pan and rotation and restores the initial view. (identical with pressing space bar)</p>
	Zoom In
	Zoom Out



2.3.2 Mouse Modes

The [MouseModes](#) plug-in is required to display the following mouse mode buttons.

	<p>Mouse - Zoom In</p> <p>Choose this function to enlarge segments using the mouse. Click on the image and drag the frame over the desired segment. Alternatively you can click on the image, without marking a segment. The image will then be magnified in steps. To zoom out in steps, hold down the CTRL-key and click on the image.</p>
	<p>Mouse - Pan</p> <p>Choose this function to pan the image using the mouse. Click on the image and drag in the desired direction. To return to the original view, hold down the CTRL-key and click on the image.</p>

	<p>Mouse - Turn</p> <p>Choose this function to rotate the image around the z-axis. Click on the image and drag in whatever direction you want to turn the object (to the right or the left). To reset the rotation, hold down the CTRL-key and click on the image.</p>
	<p>Mouse - Rotate (only for 360° presentations)</p> <p>Choose this function to rotate the object around the y-axis or the x-axis if available. Click on the image and drag to the left or to the right. Move the mouse up or down to rotate the object around the x-axis. To reset rotation, hold down the CTRL-key and click on the image.</p>

2.3.3 Additional Buttons

	<p>Hide / Display menu</p> <p>Displays or hides the user interface.</p>
	<p>Information</p> <p>Displays information about the viewer (optional, can be hidden by altering the skin CSS)</p>

2.3.4 Using the navigator window

In the navigator window you can see a miniature presentation of the entire image. The segment which is currently viewed is framed. In the navigator window you can change the current segment either by dragging the frame or by clicking on the desired area of the image.

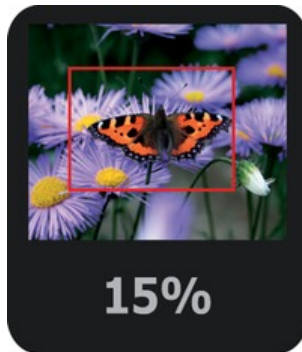

2.4 Index structure of FSI Viewer

The index structure of the JS viewers as found in *fsi/web/viewer/*:

Directory	Content Description
applications	contains the .js scripts for the according viewers
config	contains the configuration files
languages	User interface language files
skins	FSI Skins containing the visible parts of the user interface

**Please note:**

You need to make sure that your web server properly serves files with the following extensions: *.js, *.xml

2.5 Configuration

2.5.1 Enabling the Debug Mode

The debug mode can be enabled or disabled by passing the "Debug" parameter either in the code snip or in an XML configuration file.

Please use "debug=1" or "debug=true" to enable the debug mode and "debug=0" (or omit the debug parameter) to disable the debug mode. To disable the debug mode permanently you can safely delete the "/debug" directory of your FSI setup directory.

Example:

```
<body>
<fsi-viewer width="500" height="600" src="/images/
foo.tiff" debug="true">
</fsi-viewer>
</body>
```

Example:

If FSI Viewer does not work or look as expected in an HTML page you can quickly debug FSI Viewer as follows:

- Open the HTML page containing FSI Viewer
- Open the "Inspect Element" feature of your browser
- In the "Console" and "Network" part you can now check if everything is implemented and loaded correctly

2.5.2 Using XML Configuration Files (*.xml)

FSI Viewer uses XML configuration files which can easily be edited with any text editor.

The default configuration file "_default.xml" - which is located in `/fsi/web/viewer/` is the most important XML configuration file and will always be evaluated first.

To use FSI Viewer with additional configuration files you have to place the file in the `/fsi/web/viewer/config/` folder and provide the name of the configuration file using the "cfg" parameter in the code:

Using FSI Viewer Configuration Files

```
<head>
//adding the fsiviewer.js script
<script src="js/fsiviewer.js" type="text/javascript"></
script>
</head>
<body>
//Example with using a FSI Viewer configuration file:
<fsi-viewer width="500" height="600"
src="/images/sample.jpg" cfg="sample_configuration">
</fsi-viewer>
</body>
```

This will load the `/fsi/web/viewer/config/sample_configuration.xml` file as the FSI Viewer JS configuration.

Configuration files are structured into configuration groups (XML nodes) containing parameter names and values. Only parameters in these groups will be recognized by FSI Viewer. Configuration files do not need to contain all groups though. Each parameter has to be provided as an individual XML child node of a group where the node name is the parameter name and the parameter value needs to be provided as "value" attribute of the node.



Note:

It is possible to implement viewer parameters in the XML configuration using specific viewer nodes, e.g.

- <Viewer>
- <TouchZoom>
- <QuickZoom>
- <Pages>
- <Thumbbar>

This enables you for example to implement globally used FSI Viewer, FSI TouchZoom, FSI Pages, FSI ThumbBar or FSI QuickZoom parameters in the `_default.xml` or for certain viewers with an individual configuration `.xml` file.

Structure of XML configuration files

```
<fsi_parameter>
  <image>
    <parameter value="" />
  </image>

  <Viewer>
    <parameter value="" />
  </Viewer>

  <plugins>
    <parameter value="" />
  </plugins>

  <options>
    <parameter value="" />
  </options>
</fsi_parameter>
```

Simple Configuration File

```
<fsi_parameter>
  <image>
    <path value="samples/Watch.jpg" />
  </image>
  <Viewer>
    <skin value="silver" />
    <debug value="1" />
    <noNav value="true" />
  </Viewer>
  <TouchZoom>
    <useDevicePixelRatio value="true" />
    <enableByCSSClass value="zoom-image" />
    <zoomPrecision value="3" />
  </TouchZoom>
</fsi_parameter>
```

Please keep in mind the following rules when using XML configuration files:

- Attribute values must be provided in double quotes
- The last occurrence of a given parameter will be used
- Configuration files might be cached by your browser, so that changes in these files require flushing the browser cache. This does not apply when using the debug mode.
- Make sure to save configuration files in UTF-8 format if your configuration file contains language specific diacritics, Japanese characters and alike

You can comment on or disable sections of an XML configuration file using the usual XML comment syntax:

Comments

```

<image>

  <!-- This is a comment -->
  <path value="image.tif" />

  <!-- The following section will be ignored -->
  <!--
  <path value="anotherimage.tif" />
  -->
</image>

```

2.5.3 Hierarchy of Configuration Parameters

As explained before parameters can be provided in two different ways:

1. The default configuration file "_default.xml" - located in /fsi/web/viewer/ - will always be evaluated first
2. You can store image specific parameters in additional *.xml files in /fsi/web/viewer/config/
3. You can override parameters from either configuration file by specifying them in the <fsi-viewer> tag

Parameters specified in multiple ways – for example in the default configuration and by custom configuration files– will be evaluated in the following way:

- Parameters defined in configuration files override parameters defined in the default configuration file "_default.xml".
- Parameters defined in the <fsi-viewer> tag override parameters defined in the custom configuration file.

The list below shows the hierarchy resulting from the sequential evaluation of the different configuration methods:

Configuration Hierarchy

1. Parameters set in the HTML tag
2. Configuration file (*.xml)
3. Default configuration file (_default.xml)

Choosing the adequate Configuration Method

So far you learned that FSI Viewer can be configured by any combination of:

- Parameters set in the HTML tag
- Additional configuration files (*.xml)
- The default configuration file (_default.xml)

These configuration options are not only alternate methods. Combining these methods offers the possibility to provide configuration parameters as easily as possible and as dynamically as required. The following considerations might be helpful when deciding which method to choose for a certain parameter.

Concerning the configuration via configuration files or the default configuration file, in earlier versions it was possible to define global parameters via the <Options> node (e.g. skin). This is still possible, but if a parameter is defined in the custom viewer node (e.g. skin is set to white in the <Viewer> node), this parameter is superior to the one defined in the <Options> node.

Default Configuration

You can easily change global parameters that apply to all FSI Viewer instances by editing a single file. This is therefore the recommended configuration method for:

General configuration options like:

- Skin
- Language

- MenuAlign, AnimationSpeed and alike

Configuration Files

Separate configuration files should be used for parameters specific to a group of images or a specific way to display images. You might for example want to setup individual configuration files for different types of FSI Viewer JSinstances, like "small_no_interface.xml", "large_with_hotspots.xml" as an example.

Usually you don't need to create a configuration file for individual images, as you can specify the image path or other unique parameters dynamically in the code.

2.5.4 Conditional Configuration Options

Conditional options are parameter blocks being evaluated if one or more conditions are met.

Example:

```
<fsi_parameter>
  <if parameter="renderer" value="png">
    <options>
      <effects value="Sepia()" />
      <renderer value="jpeg" />
    </options>
  </if>
```

The "options" block containing the "effects" and "renderer" parameters applies only, if "renderer" equals "png".

When are the conditions evaluated?

Conditional options are evaluated after the non-conditional parameters and after applying parameters by query and/or arguments.

When to use conditions in configurations?

Conditions are evaluated client side each time a viewer instance is loaded. Therefore do not use too complex conditions and use them if required only.

You could e.g. define a specific UI skin depending on the directory a source image resides in. The recommended way in this case though would be to assign the "skin" attribute to the viewer's HTML tag.

A good example **when** to use conditions is using the "@mobile" parameter in conditions. If you use FSI Viewer and would like to hide the UI on mobile devices, this condition does the trick:

Example:

```
<fsi_parameter>  
  
  <if parameter="@mobile" value="true">  
    <viewer>  
      <HideUI value="true" />  
    </viewer>  
  </if>
```

Cascaded Conditions

If multiple conditions should be met to apply parameters, you can cascade conditions:

Example:

```
<fsi_parameter>

  <if parameter="renderer" value="sw1">
    <if parameter="quality" operator="lessThanEqual"
value="50" >
      <options>
        <effects value="Sepia()" />
      </options>
    </if>
  </if>
```

The "options" block containing the "effects" and "renderer" parameters applies only, if

- "renderer" equals "sw1"

AND

- "quality" <= 50

Conditions and Groups

Conditions can appear within groups like <options>, <viewer>, <pages> and alike.

In this case they are only evaluated, if the group matches for the viewer in use.

That means a condition in `<pages>` will be ignored by FSI Viewer. This is the recommended way if a conditions applies to a single viewer type only.

Example:

```
<fsi_parameter>

  <pages>
    <if parameter="renderer" value="png">
      <effects value="Sepia()" />
      <renderer value="jpeg" />
    </if>
  </pages>
```

If a condition should apply to all viewer types you can add the condition to the `<options>` group.

In case you want a condition to apply to multiple viewer types, but NOT to all, you can add the groups in question to the condition. The content of the groups does not need to be the same. If it should be the same, you need to repeat it in each viewer group:

Example:

```

<fsi_parameter>

  <if parameter="renderer" value="sw1">
    <pages>
      <effects value="Sepia()" />
    </pages>

    <viewer>
      <effects value="Sepia()" />
    </viewer>
  </if>

```

Building Conditions

The tag name of conditions must be "if".

The following attributes are supported:

- **parameter:** Mandatory. The name of the configuration parameter to compare. E.g. "language", "imageSrc", "dir", etc.
- **value:** Mandatory. The value to compare the configuration parameter to.
- **operator:** Optional. Defaults to "=". The operator to use for the comparison.

Supported Operators in Conditions:

=	equals (case insensitive)	(aliases: eq)
==	equals (case sensitive)	(aliases: none)
!=	not equal (case insensitive)	(aliases: not)
!=	not equal (case sensitive)	(aliases: none)

<	less than (numerical)	(aliases: lt, lessThan)
<=	less than or equal (numerical)	(aliases: lte, lessThanEqual)
>	greater than (numerical)	(aliases: gt, greaterThan)
>=	greater than or equal (numerical)	(aliases: gte, greaterThanEqual)
match	match a JS regular expression	(aliases: none)
notmatch	not match a JS regular expression	(aliases: none)



Please note:

As "<" and ">" may not be used in XML attribute values, you should use the alias instead (e.g. "lt" instead of "<". You can as well use the entity "<", but this doesn't look to good.

Regular Expressions (operator "match" and "notmatch")

Please assign a JavaScript regular expression like you would in a browser to the "value" attribute of the condition. The following example matches all source images ending with ".tif":

Example:

```
<if parameter="imagesrc" operator="match" value="/.*\.tif$/gi" >
  <options>
    <effects value="Sepia()" />
  </options>
</if>
```

What parameter values can I use for conditions?

You can use all configuration parameters as you would use them in a URL. E.e. use "imagesrc" for `<image><src value="foo" />`

In addition you can use a small number of device dependent parameters prefixed with "@".

The following table lists possible values:

Name	Possible values	Description
@mobile	true/false	true for mobile devices, false for desktop devices
@devicepixelratio	>= 1.0	device pixel ration of the user's device
@navigatorUserAgent	String	User agent value of the user's browser
@navigatorLanguage	String	navigator.language of the user's browser

@navigatorPlatform	String	navigator.platform of the user's browser
--------------------	--------	--

2.5.5 Retrieving Parameters from FSI Server

FSI Viewer is capable of retrieving image specific parameters from FSI Server dynamically. This way you do not need to define these parameters explicitly. The list below shows some typical parameters that can be retrieved from FSI Server automatically:

- ImageWidth
- ImageHeight
- ImageTilesX
- ImageTilesY
- SceneSets
- Image Collections
- Hyperlinks
- Hotspots

How to access image parameters from FSI Server?

FSI Server can be queried for information on a specific folder or image by simple HTTP Request, e.g.

[http://\[domain\]/fsi/server?type=info&tpl=info.json&source=samples/sample_image.tif](http://[domain]/fsi/server?type=info&tpl=info.json&source=samples/sample_image.tif)

and will return a JSON file containing the related information. Depending on the type= and tpl= parameters, different informations can be retrieved dynamically. You can read more about the server addressing in the [Appendix](#) of the FSI Server manual.

In which case will these values be retrieved automatically?

FSI Viewer tries to retrieve the parameters ImageWidth and ImageHeight from the server if one of these values has not been defined manually. If the server delivers additional parameters (e.g. ImageTilesX, ImageTilesY) these parameters will only have an effect if they have not been defined manually.

2.5.6 Using Custom Language Files

In case you want to edit tool tips for existing languages or add support for additional languages you can edit or create language files in the subdirectory "/"languages" of your FSI Viewer setup directory.

Each language file contains a list of phrases used in FSI Viewer user interface. The language files are XML files and need to be saved in UTF-8 format. The attribute "id" specifies the context of each phrase. Please note that you need to use XML entities for characters not allowed in XML files, like e.g.

&	for "&"
<	for "<"
>	for ">"
"	for "
'	for ,

You can use basic HTML-tags to apply text formatting to the tool tips.

Excerpt from a language file:

```

<Data language="english" color="000000" font="_sans"
offsetTop="0" offsetLeft="0"
offsetWidth="0" offsetHeight="0">

    <tip id="ZoomOut">
        <b>Zoom Out</b>
        <br/>Click to decrease magnification
    </tip>

    <tip id="ZoomIn">
        <b>Zoom In</b>
        <br/> Click to increase magnification
    </tip>

    <tip id="Downloading Data">Downloading:</tip>

    [...]

</Data>

```

You can duplicate existing language files or create new files as needed.

To use custom language files, please use the "language" parameter and set the parameter value to the filename without the ".xml" extension.

It is also possible to map the available language files to the language of the browser (the file mapping.json in the \languages folder of your FSI Viewer installation can be adapted to your liking for that). In order to use the mapping defined in the JSON file, the parameter language needs to be set to "auto".

2.6 Parameters

Parameters are added to the `<fsi-viewer>` tag. Note that you can as well use FSI Viewer configuration files (required e.g. when using hot spots):

Adding Parameters to the viewer

```
<head>
//adding the fsiviewer.js script
<script src="js/fsiviewer.js" type="text/javascript"></script>
</head>
<body>

//Adding parameters directly to the tag:
<fsi-viewer width="500" height="600" src="/images/sample.jpg"
debug="true" skin="silver">
</fsi-viewer>
//Example with using a FSI Viewer configuration file:
<fsi-viewer width="500" height="600" src="/images/sample.jpg"
cfg="sample/sample_configuration">
</fsi-viewer>

</body>
```

You can define individual configuration .xml files like this:

Simple Configuration File

```
<fsi_parameter>

  <image>
    <path value="samples/Watch.jpg" />
  </image>

  <Viewer>
    <skin value="silver" />
    <debug value="1" />
    <noNav value="true" />
  </Viewer>

</fsi_parameter>
```

If you would like to use global parameters for all FSI Viewer instances, the corresponding parameters can be defined in the `_default.xml`.

Example_default.xml:

```
<fsi_parameter>
  <Image>
    <ServerType value="FSI"/>
  </Image>

  <Viewer>
    <skin value="white" />
    <inPlaceZoom value="true" />
    <hideUI value="false"/>
    <adaptiveuisize value="true"/>
  </Viewer>
  ...
  <Options>
    <FSIBase value="config"/>
    <Language value="english"/>
    <ScenePreload value="true"/>
  </Options>
</fsi_parameter>
```

You can optionally modify the way FSI Viewer works by passing parameters to the script. To do so, pass an object containing the parameters and value as an object to the constructor:

Example:

```
var node = document.createElement("fsi-viewer");

node.style.width = "600px";
node.style.height = "400px";

var parameters =
{"imagesrc" : "images/Rocker Shoe.tif", "skin":"silver",
"debug":true};
$FSI.setParameters(node, parameters);
document.body.appendChild(node);

// Important: call this AFTER adding the node to the DOM
$FSI.initCustomNode(node);
```

⚠ Note:

`$FSI.initCustomNode(node)` initializes the given node.

When adding multiple viewers you can initialize all new FSI Viewer nodes in one go, using this command:

```
$FSI.initCustomTag("fsi-viewer");
```

or, when using different custom tags (fsi-viewer, fsi-imageflow,...):

```
$FSI.initCustomTags(); to initialize all new FSI custom tags.
```

2.6.1 Basic Parameters

General

debug	
Description	display debug and status information in the JavaScript console
Syntax	Boolean
Default	false
Context	FSI Viewer

Display debug and status information in the browser's JavaScript console.

headers	
Description	"&headers=" parameter to use for image requests
Syntax	String
Default	"cors"
Context	FSI Viewer

The "&headers=" parameter to use for image requests.

The default value "cors" ensures cors compatibility for cross-origin scenarios.

cfg	
Description	relative path to an XML configuration file in FSI Viewer format

cfg	
Syntax	String
Default	""
Context	FSI Viewer

The relative path to an XML configuration file in FSI Viewer format.

When using a relative path the location specified by the FSI Viewer "FSIBase" parameter will be used, which is [viewer]/config/ by default.

format	
Description	defines the format used for the viewer.
Syntax	String
Default	"auto"
Context	FSI Viewer

Defines the format used for the viewer.

Default is auto which automatically chooses the best format depending on the browser; alternatively you can choose WEBP, JPEG, PNG or GIF.

Auto delivers the images adaptively as WEBP in supporting browsers, and switches to PNG or JPEG on unsupported browsers.

If you set WEBP as a format, please keep in mind that certain browsers (currently Safari and Internet Explorer) do not support the format and will not show the image.

If you would like to use WEBP, the best way would be to set auto as the format.

navWidth	
Description	defines the width of the navigation frame
Syntax	String
Default	"120"
Context	FSI Viewer

Defines the width of the navigation frame displayed in the right corner on the bottom.

navHeight	
Description	defines the height of the navigation frame
Syntax	String
Default	"120"
Context	FSI Viewer

Defines the height of the navigation frame displayed in the right corner on the bottom.

urlLoadingAnimation	
Description	defines the loading animation shown
Syntax	string
Default	"/skins/resources/loading.svg"
Context	FSI Viewer

Defines the loading animation shown. Custom animations can be placed here: /skins/resources/. Setting the parameter to "false" discards the display.

InvisibleLoadingPurposes	
Description	defines if the loading animation should be excluded under certain circumstances
Syntax	string
Default	-
Context	FSI Viewer

Defines if the loading animation should be excluded under certain circumstances. Per default it is activated whenever the viewer loads images. Setting the parameter to "asyncResize" omits the loading animation when asynchronous loading takes place, e.g. when the viewer is switched to FullScreen and the higher resolution images need to be loaded. "tile" omits the presence of the loading animation when tiles are loaded, e.g. when the user zooms into the picture. It is also possible to combine both as "tile,asyncResize" - in this case the loading animation is only shown in the initial loading sequence.

skin	
Description	defines the skin to display
Syntax	string
Default	"black"
Context	FSI Viewer

Defines the skin which will be displayed. FSI Viewer comes with three default skins, "black", "white" and "silver".

Skins are defined via CSS and can be found here: /fsi/web/viewer/skins.

It is also possible to alter existing skins or to define custom skins in this location.

In order to use a custom skin, the easiest way would be to duplicate one of the default skin CSS files and adapt them to your liking. Make sure to use a custom class in front of ALL classes defined in the custom CSS, otherwise you will break other skins on the same HTML document.

To see an example file, please go to the [Appendix](#).

General appearance CSS rules, which are valid on an overall level, (e.g. the logo container, height of the menubar, etc.) are defined in the corresponding core CSS files, which can be found in `/fsi/web/viewer/skins/resources`. (`fsi-core.css`, `fsi-viewer-core.css`)



IMPORTANT:

Never change the classes of the core CSS in the core files directly. If you would like to adapt the CSS rules listed there, please overwrite them in a custom skin file or in the HTML document instead.

You can find detailed tutorials for changing the appearance of the skin in the [support section of our website](#):

- [Create Basic Skins for FSI Viewer/ FSI Pages JS](#)
- [Create Advanced Skins for FSI Viewer/ FSI Pages JS](#)
- [Create Custom Buttons for Skins](#)
- [Create a Custom Skin using JavaScript](#)

For a detailed example of a basic custom skin, please go to "[Example of a custom skin CSS file](#)".

dir	
Description	path to the source images for the object spin on FSI Server
Syntax	String
Default	""
Context	FSI Viewer

The path to the source images for the object spin on FSI Server.

The viewer will load the list of images from the given directory.

src	
Description	path to the single images used for FSI Viewer
Syntax	String
Default	""
Context	FSI Viewer

Defines the path to single images used for FSI Viewer.

imagesources	
Description	paths to single images used for FSI Viewer
Syntax	String
Default	""
Context	FSI Viewer

Defines the paths to single images used for FSI Viewer. Example: "dir1/1.jpeg, dir1/2.jpeg, dir2/1.jpeg,..."

imageListLimit	
Description	limits the image list to a certain amount of images
Syntax	String
Default	""
Context	FSIViewer 360

FSI Viewer 360° only. Does not apply to a single image FSI Viewer instance. Limits the image list to a certain amount of images within the directory. The parameter is used like this: "0,10" - the first value defines the starting image, the second the amount of images displayed. In this case it would start at the first image and show the first ten images. "5,5" would start the list with the fifth image and shows the fifth image plus the four images that are listed behind it.

imageListSort	
Description	sorts the image list
Syntax	String
Default	"filename"
Context	FSIViewer 360

FSI Viewer 360° only. Does not apply to a single image FSI Viewer instance. Sorts the image list with any valid sort item name for FSI Server. Available sort names:

- "filename" (default)
- "width"
- "height"
- "lastmodified"

- "resolution"
- "importstatus"

imageListSortOrder	
Description	defines the order of the image list sorting
Syntax	String
Default	"asc"
Context	FSI Viewer 360

FSI Viewer 360° only. Does not apply to a single image FSI Viewer instance. Defines the order of the image list sorting. Possible values: "asc" (Ascending) or "desc" (Descending).

ListFilterPositive	
Description	filters the image list using RegEx, includes matching images
Syntax	String
Default	-
Context	FSI Viewer 360

FSI Viewer 360° only. Does not apply to a single image FSI Viewer instance. Filters the image list to a certain amount of images within the directory using RegEx. If images match the Regular Expression, they will be included in the image list. If both ListFilterPositive and ListFilterNegative are used, ListFilterPositive is always used first. The filter will be applied before any other parameter is applied, i.e. if SceneSets is set, it only applies to the already filtered list.

Example: ListFilterPositive="/8.TIF\$/i"

ListFilterNegative	
Description	filters the image list using RegEx, excludes matching images
Syntax	String
Default	-
Context	FSI Viewer 360

FSI Viewer 360° only. Does not apply to a single image FSI Viewer instance. Filters the image list to a certain amount of images within the directory using RegEx. If images match the Regular Expression, they will be excluded of the image list. If both ListFilterPositive and ListFilterNegative are used, ListFilterPositive is always used first. The filter will be applied before any other parameter is applied, i.e. if SceneSets is set, it only applies to the already filtered list.

Example: ListFilterNegative="/8.TIF\$/i"

language	
Description:	Defines the language of the tooltips
Syntax:	String
Default:	—
Context:	FSI Viewer

The language parameter can be used to adapt the tooltips which are shown while hovering over a button to a certain language. The available languages can be found in the \languages folder of your FSI Viewer installation. (See [Using Custom Language Files](#) for more info).

It is also possible to map the available language files to the language of the browser (the file mapping.json in the \languages folder of your FSI Viewer

installation can be adapted to your liking for that). In order to use the mapping defined in the JSON file, the parameter language needs to be set to "auto".

effects	
Description:	Image manipulation parameters for all images
Syntax:	String
Default:	—
Context:	FSI Viewer

The effects parameter can be used to pass image manipulation parameters to the imaging server. Typical manipulation parameters include the image saturation ("saturation") and image sharpening ("sharpen"). If no effect is specified, the default settings of the server (profile) apply.

In contrast to all other parameters, defining the parameter "effect" adds(!) the string to the existing effects parameter.

E.g. if your configuration file contains: `<effects value="blur(10)" />` and you add to your `<fsi-viewer>` tag `effects="sepia()"`, the resulting effects parameter value is: `blur(10),sepia()`.

If you want to overwrite existing effects values, you can start the effects parameter with `"ClearEffects()"`.

In the example above, if you add `effects="ClearEffects(),sepia()"` to your `<fsi-viewer>` tag, the resulting effects parameter value is `"sepia()"` only.



Please note:

ClearEffects() must be written exactly like this and must be at the start of the "effects" parameter value.

Please refer to your [FSI Server documentation](#) for a list of available effect parameters.

initialView	
Description	defines the initial image segment
Syntax	String
Default	"1,1,0,0,1,1"
Context	FSI Viewer

Image section (and rotation) to display on startup.

The first two parameters are required as they specify the scene set and the scene. For 2D images both values default to 1.

The other parameters are optional and specify the image segment with Left, Top, Right, Bottom.

initialViewPersistent	
Description	Keep the InitialView as default view
Syntax	boolean
Default	false
Context	FSI Viewer

If this parameter is activated, clicking the "Reset" button will display the image section defined by the InitialView parameter instead of the entire image. If this parameter is set to "false", the initial view will be displayed on startup, but pressing the Reset button will reset the view to the entire image.

panLimits	
Description	determines how far the user is allowed to pan
Syntax	String
Default	"strict"
Context	FSI Viewer

Determines how far the user is allowed to pan. Possible settings are: "loose", "medium", "strict"

easingZoom	
Description	determines the easing function for zoom and pan.
Syntax	String
Default	"easeOutCubic"
Context	FSI Viewer

Determines the easing function for zoom and pan. Possible settings are:

- easeOutCubic: end motion slowly
- easeLinear: no easing, linear motion
- easeOutBounce: end motion bouncing
- easeOutQuint: end motion faster

easingSpin	
Description	determines the easing function for object spins.
Syntax	String

easingSpin	
Default	"easeOutCubic"
Context	FSI Viewer

Determines the easing function for object spins. Possible settings are:

- easeOutCubic: end motion slowly
- easeLinear: no easing, linear motion
- easeOutBounce: end motion bouncing
- easeOutQuint: end motion faster

preventImageTransparency	
Description	prevents the image transparency
Syntax	Boolean
Default	false
Context	FSI Viewer

Prevents using the image transparency if a transparency channel exists.

useDevicePixelRatio	
Description	Use the device's pixel ratio to display even sharper images.
Syntax	Boolean
Default	true
Context	FSI Viewer

Use the device's pixel ratio to automatically display even sharper images.

drawCube	
Description	draws a 3D cube wireframe representing the spin object space
Syntax	boolean
Default	false
Context	FSI Viewer

Draws a 3D cube wireframe representing the object space of the spin as defined by the "virtualSpace" parameters.

The drawCube option can be useful to validate the "virtualSpace" parameters.



This option only works on desktop computers using the HTML canvas element.

drawTable	
Description	draws a virtual rotating table plate
Syntax	boolean
Default	false
Context	FSI Viewer

Draws a virtual rotating table plate.



This option only works on desktop computers using the HTML canvas element.

tableDiameter	
Description	defines diameter of virtual rotating table plate
Syntax	Float
Default	950
Context	FSI Viewer

Defines the diameter of the virtual rotating table plate in mm.

 This option only works on desktop computers using the HTML canvas element.

drawGroundPlate	
Description	draws a virtual ground plate
Syntax	boolean
Default	false
Context	FSI Viewer

Draws a virtual ground plate.

 This option only works on desktop computers using the HTML canvas element.

initialMouseMode	
Description	Mouse mode on startup
Syntax	String
Default	"auto"
Context	FSI Viewer

Specifies the selected mouse mode on startup.

Possible values:	
0:	(Zoom)
1:	(Pan)
2:	(Spin 360°)

menuButtonOrder	
Description	defines the button order of the menu bar buttons
Syntax	String
Default	-
Context	FSI Viewer

Defines the button order of the menu bar buttons. The buttons need to be listed in a string with the corresponding button IDs.

The following button IDs currently exist:

Reset, ZoomOut, ZoomIn, MouseMode_0, MouseMode_1, MouseMode_2, MaxZoom, HotSpots, ToggleAutoSpin, ToggleFullScreen

autoDestroy	
Description	automatically destroy instances
Syntax	boolean
Default	true
Context	FSI Viewer

Automatically destroy instances created with the fsi-viewer tag upon removing the tag from the document DOM.

DemoURL	
Description	URL to the website that should be opened on click (or alternatively, go to FullScreen)
Syntax	string
Default	
Context	FSI Viewer

The URL to the website that should be opened while clicking on the demo thumbnail.

Alternatively:

- "no action": the click will do nothing at all
- "enter fullscreen" : enter fullscreen and exit demo mode, returns into demo mode after leaving fullscreen mode

DemoURLTarget	
Description	target frame for DemoURL to open in
Syntax	string
Default	"_self"
Context	FSI Viewer

The target frame for DemoURL to open in.

HideUIInDemoMode	
Description	Hide UI elements in demo mode
Syntax	boolean
Default	true
Context	FSI Viewer

Hide UI elements (menu bar and alike) in demo mode.

DemoToolTip	
Description	Tool tip to show when in demo mode.
Syntax	string
Default	
Context	FSI Viewer

Tool tip to show when in demo mode.

Example for custom HTML:

```

<DemoToolTip>
  <b>Demo Mode</b><br/>
  Click to view image in full screen mode
</DemoToolTip>

```

spinDirectionImage

Description	defines direction of rotation
Syntax	String
Default	"left"
Context	FSI Viewer

Specifies the direction of the spin rotation.

SceneSets

Description	Scene sequence definition
Syntax	String
Default	1 – n tiles
Context	FSI Viewer

Using this parameter you can define scene sets for 360° views. Scene sets define the order of scenes to be displayed.

The default is a single scene set containing all scenes (image tiles) from scene 1 to the last scene image. The default sequence is left to right, top to bottom in a tile image and the sequence of the <image> nodes for 360° views based on individual source images.

In the viewer scenes can be selected by moving the mouse horizontally and scene sets can be selected by moving the mouse vertically.

Syntax:

Individual sets have to be separated with ";" (semicolon).

Scenes within the sets are separated with "," (comma) and specify the I-based index of the image from left to right, top to bottom up to the total number of scenes

(TilesX x TilesY or individual source images).

Instead of individual scenes you can also specify scene ranges, e.g. "5-10".

If you leave out the start or the end of a scene range, 1 or respectively the last scene will be assumed in this case. If you specify a range using "->" the scenes from the first number to the last scene image plus the first scene image up to the second number will be assumed.

Example:

```
SceneSets="1-12;13-24;25-36;37-48"
```

reverseSceneSets	
Description	reverses the Scene Sets
Syntax	boolean
Default	false
Context	FSI Viewer

Reverses the order of the Scene Sets.

NoSetLoop	
Description	No 360° rotation around the y-axis
Syntax	Boolean
Default	false
Context	FSI Viewer

The first and the last scene set will be considered ending points. (E.g. for partial rotations < 360°).

Please note: The blur animation is turned off if NoSetLoop is activated.

NoSceneLoop	
Description	No 360° rotation around the x-axis
Syntax	Boolean
Default	false

NoSceneLoop	
Context	FSI Viewer

The first and last scene in the each scene set will be considered ending points. (E.g. for partial rotations < 360°).

Please note: The blur animation is turned off if NoSceneLoop is activated.

ScenePreload	
Description	Load scenes in high resolution
Syntax	Boolean
Default	false
Context	FSI Viewer

If this parameter is activated (default) all scenes will be loaded at high resolution on startup. Otherwise preview images will be loaded with at a lower resolution. This parameter can significantly influence loading times and traffic volumes.

Setting this parameter to false leads to faster startup times and high resolution scene images will be loaded as soon as they need to be displayed.

Display Options

hideUI	
Description	hides the user interface
Syntax	string
Default	false
Context	FSI Viewer

Hides or displays the user interface.

Possible values:	
true	
false	
onMobileDevices:	UI is hidden on mobile devices
ifNoInPlaceZoom:	UI is hidden if in place zoom is deactivated

noNav	
Description	hides the navigation window
Syntax	boolean
Default	false
Context	FSI Viewer

Hides or displays the navigation window.

autoHideNav	
Description	automatically hides the navigation window
Syntax	boolean
Default	false
Context	FSI Viewer

Hides or displays the navigation window automatically if the magnification is at minimum.

autoSpinSpeed	
Description	Time in seconds for a full rotation
Syntax	float
Default	-
Context	FSI Viewer

Time in seconds for a full rotation. Negative values reverse spin direction.

autoSpinInterval	
Description	defines pause between every step in ms
Syntax	float
Default	-
Context	FSI Viewer

Can be used instead of autoSpinSpeed to define the duration of the AutoSpin. autoSpinInterval defines the pause between every step of the rotation in ms. Negative values reverse spin direction. The hierarchy of the parameters is as follows:

- autoSpin_interval (Plugin Parameter)
- autoSpinInterval (Config Parameter)
- autoSpin_speed (Plugin Parameter)
- autoSpinSpeed (Config Parameter)

enableZoom	
Description	enable the user to zoom in and out
Syntax	Boolean
Default	true
Context	FSI Viewer

Enable the user to zoom in and out.

On touch enabled devices the zoom is based on the native pinch zoom gesture. On non touch enabled devices, in place zoom by clicking the object or dragging up/down will be enabled instead. Alternatively, the menu bar can be used for zooming.

desktopClickZoomScale	
Description	the magnification level to use when clicking the object
Syntax	Float
Default	3
Context	FSI Viewer

For desktop browsers only. The magnification level to use when clicking the object.

backgroundColor	
Description	the background color to use
Syntax	6-digit hex-color
Default	#FFFFFF

backgroundColor	
Context	FSI Viewer

The background color to use. The color should match the video's or image's background color (usually white or black).

mouseSensitivity	
Description	sensitivity of the mouse movement when rotating the object
Syntax	float
Default	1.0
Context	FSI Viewer

Sensitivity of the mouse (finger) movement when rotating the object.

pellets	
Description	viewer draws optionally small dots on the video
Syntax	boolean
Default	true
Context	FSI Viewer

When using a spin video you can optionally have the viewer draw small dots on the

video. This improves the visual impression of the video in higher resolutions.

pelletsOpacity	
Description	defines opacity of the dots ("pellets") drawn on the video
Syntax	float
Default	0.09
Context	FSI Viewer

Opacity of the dots ("pellets") drawn on the video, if the pellets parameter is enabled.

adaptiveUISize	
Description	determines if interface scales according to the zoom level .
Syntax	Boolean
Default	true
Context	FSI Viewer

When set to true, the interface scales according to the zoom level.

inPlaceZoom	
Description	activates zooming in the FSI Viewer instance
Syntax	string
Default	"true"

inPlaceZoom	
Context	FSI Viewer

The parameter defines if in-place-zoom (zooming directly in the FSI Viewer instance) is activated.

Possible values:	
true	
false	
auto:	in-place-zoom is activated, but not on mobile devices

documentZoom	
Description	allows pinch-zoom on FSI Viewer instance
Syntax	string
Default	"auto"
Context	FSI Viewer

Activates pinch document zoom on FSI Viewer instance.

Possible values:	
true	
false	
auto:	pinch document zoom is activated on all touch-enabled devices

autoDisablePointerActions	
Description	disables events if viewer is larger than viewport
Syntax	Boolean
Default	true
Context	FSI Viewer

Disables mouse and touch events if viewer's height OR width is larger than the viewport width or height.

loadExactPreviewImagesAfterResize	
Description	Reload images in the new required resolution after a resize event
Syntax	Boolean
Default	"true"
Context	FSI Viewer

Reload images in the new required resolution after a resize event.

maxZoom	
Description	defines the maximum magnification level
Syntax	Float
Default	100

maxZoom	
Context	FSI Viewer

Defines the maximum magnification level.

minInstanceSize	
Description	defines the minimum instance size
Syntax	Integer
Default	60
Context	FSI Viewer

Defines the minimum instance size of the viewer.

Preview Options

showPreviewWhileLoading	
Description	shows/hides preview images for spins while loading
Syntax	boolean
Default	true
Context	FSI Viewer

If this parameter is set to false, the preview images which are shown while the spin is loaded are hidden.

spinPreviewWhileLoading	
Description	shows/hides preview images for spins while loading
Syntax	boolean
Default	true
Context	FSI Viewer

If this parameter is set to false, a static image will be shown instead of the spin while loading. If `initialView` is defined, the image defined there will be shown.

showProgressbar	
Description	shows/hides progress bar while loading
Syntax	boolean
Default	true
Context	FSI Viewer

If this parameter is set to false, the progress bar which is shown while the spin is loaded is hidden.

progressBarWidth	
Description	defines the width of the progress bar
Syntax	float
Default	35
Context	FSI Viewer

Defines the width of the progress bar in percent of the viewport width.

progressBarHeight	
Description	defines the height of the progress bar
Syntax	float
Default	14
Context	FSI Viewer

Defines the height of the progress bar in pixel.

progressBarHAlign	
Description	defines the horizontal position of the progress bar
Syntax	string
Default	"center"
Context	FSI Viewer

Defines the horizontal position of the progress bar, possible values: left, center, right.

progressBarVAlign	
Description	defines the vertical position of the progress bar
Syntax	string
Default	"bottom"
Context	FSI Viewer

Defines the horizontal position of the progress bar, possible values: top, middle (or center), bottom.

Global Parameters for Hot Spots

enableHotspots	
Description	enables or disables hot spots
Syntax	boolean
Default	true
Context	FSI Viewer

You can set this value to false if hot spots have been defined, but should not be displayed.

hotspotCallbackFunction	
Description	callback function for hot spots
Syntax	string/ function
Default	""
Context	FSI Viewer

The name of a custom JavaScript callback function in window scope to call each time a hot spot mouse action occurs.

Alternatively you can pass the function directly as a JavaScript parameter.

Example of a callback function prototype:

Callback Function Prototype:

```
function onFSIViewerHSAction(strAction, viewer,
idViewer, idHotspot, node, param, angle) {
  if (strAction == "click") {
    alert("clicked on hot spot " + idHotspot);
  }
}
```

Attribute	Description
action	a string representing the action "mouseover", "mouseout", "mousedown" or "click"
viewer	the FSI Viewer viewer instance calling the method
idViewer	the value of the "id" attribute of the viewer's <div> tag
idHotspot	the 0-based id of the hotspot
node	the <div> node containing the hot spot content
param	the content of the "actionParameter" parameter of the hot spot
angle	the hot spot's perimeterAngle value (the angle at which it's visible best)

hotspotLineColor1	
Description	lighter color of the hot spot marker lines
Syntax	6-digit hex color
Default	#FFFF00
Context	FSI Viewer

The lighter color of the hot spot marker lines.

hotspotLineColor2	
Description	darker color of the hot spot marker lines
Syntax	6-digit hex color
Default	#000000
Context	FSI Viewer

The darker color of the hot spot marker lines.

hotspotDotColor1	
Description	lighter color of the hot spot marker lines
Syntax	6-digit hex color
Default	#FFFF00
Context	FSI Viewer

The lighter color of the hot spot marker circle's gradient.

hotspotDotColor2	
Description	darker color of the hot spot marker lines
Syntax	6-digit hex color
Default	#000000
Context	FSI Viewer

The darker color of the hot spot marker circle's gradient.

decodeHTMLEntitiesInHotSpotTexts	
Description	enables html entities in the hotspots text
Syntax	Boolean
Default	false
Context	FSI Viewer

When enabled, basic HTML entities will be enabled in the hotspot text.

hotspotDotRadius	
Description	radius of the hot spot marker circle in px
Syntax	float
Default	4.0
Context	FSI Viewer

The radius of the hot spot marker circle in px.

Camera Section

The camera section contains parameters describing the technical specifications and the position of the camera when shooting the 360° spin.

You only need to specify these values if you are using the virtual space, e.g. for hot spots.

For 2D zoom and spins without hot spots you can omit this parameter group.

digitalCropFactor	
Description	depends on the size of the optical sensor chip of the camera
Syntax	float
Default	1.0
Context	FSI Viewer

The value depends on the size of the optical sensor chip of the camera.

For full frame cameras the value is "1.0". Common values are between 1.5 to 1.6. The crop factor is the same factor that affects the focal length of your camera's objective. E.g. the focal length of an objective with a full frame camera is 50mm. With a camera that has a crop factor of 1.5 the effective focal length would be $1.5 \times 50\text{mm} = 75\text{mm}$.

Please note that for an accurate calculation the rounded figure (e.g. 1.5) is not precise enough, since two to four decimal places are required.

In order to ensure an exact smooth video and hotspot implementation, please do the following calculation for specific sensor dimensions of the camera used.

The size of the optical sensor chip can be found in the cameras technical specifications.

$$\frac{\sqrt{36^2 + 24^2}}{\sqrt{x^2 + y^2}} = \text{digitalCropFactor}$$

$36^2 + 24^2 =$ Reference value
(35mm "full frame" format; 36mm x 24mm,
crop factor: 1.0)

$x^2 + y^2 =$ Sensor dimensions of your camera
(width and height)

Please find below the calculation for a Canon 7D camera (which has the sensor dimensions of 22.3mm x 14.9mm) as an example:

$$\frac{\sqrt{36^2 + 24^2}}{\sqrt{22.3^2 + 14.9^2}} = 1.6132$$

focalLength	
Description	focal length of the camera objective
Syntax	float (in mm)
Default	50
Context	FSI Viewer

The focal length of the camera objective.

position, targetPosition	
Description	defines the position of the camera and the object
Syntax	float (in mm)
Default	
Context	FSI Viewer

position(x,y,z) and targetPosition(x,y,z) can be used instead of distanceToTableCenter, heightAboveTable and targetHeightOffset. (see illustration below)

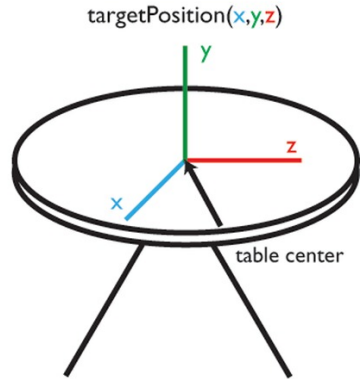
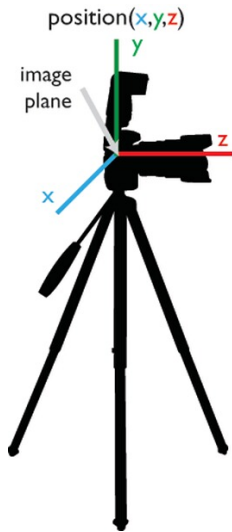

Explanation position(x,y,z)	
x	if image plane is in line with table center, x is 0
y	height of the image plane in reference to the table center
z	the distance between image plane and table center

Explanation targetPosition(x,y,z)	
x	if target is in table center, x is 0
y	height of the target in reference to the table center
z	the distance between target and table center

distanceToTableCenter	
Description	distance from cameras image plane to the center of the turntable
Syntax	float (in mm)
Default	0
Context	FSI Viewer

The straight distance from the cameras image plane to the center of the turn table in mm (see illustration below).

heightCamera	
Description	distance from image plane of the camera to the ground
Syntax	float (in mm)
Default	0
Context	FSI Viewer

The straight distance from the optical center of your camera to the ground in mm (see illustration below).

heightTable	
Description	distance from top of the turn table to the ground
Syntax	float (in mm)
Default	0

heightTable	
Context	FSI Viewer

The straight distance from the top of the turn table to the ground in mm. (see illustration below)

targetHeightOffset	
Description	height of the camera target spot at the center of the turntable
Syntax	float (in mm)
Default	0
Context	FSI Viewer

The height of the camera target spot at the center of the turn table in mm.

If you vertically target the table center the value is 0.0 mm.

(see illustration below)

targetWidthOffset	
Description	horizontal offset of the camera target spot
Syntax	float (in mm)
Default	0
Context	FSI Viewer

The horizontal offset of the camera target spot at the vertical the center of the turn table related to the center of the turn table in mm. If you target the horizontal table center (default) the value is 0.0 mm.

heightAboveTable	
Description	height of the image plane above the table
Syntax	float (in mm)
Default	500
Context	FSI Viewer

Alternative parameter if heightCamera and heightTable are unknown. Only applies if both parameters are undefined.

Camera Positioning Illustration

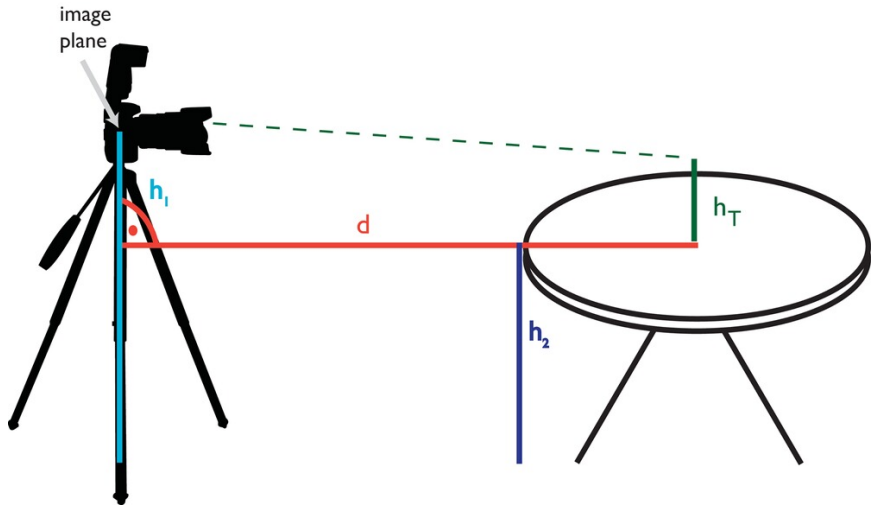

Attribute	Description
h_T	Parameter: targetHeightOffset
h_1	Parameter: heightCamera
h_2	Parameter: heightTable
d	Parameter: distanceToTableCenter

Usage of Robotic Camera Arm for rotations around the x-axis

armLength	
Description	length of the robot arm
Syntax	float (in mm)
Default	
Context	FSI Viewer

Defines the length of the robot arm; default value is the distance of the camera to the camera target. Only relevant if hotspots are used.

armJointPosition	
Description	position of the arm joint
Syntax	float (in mm)
Default	
Context	FSI Viewer

Defines the position (x,y,z) of the robot arm joint; default value is equal to the camera targetPosition. Only relevant if hotspots are used.

armAngleMeasureSetup	
Description	angle where distance from camera to target is measured
Syntax	float (in degrees)
Default	0
Context	FSI Viewer

Defines the angle from which distance from camera to target was measured. Only relevant if hotspots are used.

armStartAngle	
Description	defines the start angle
Syntax	float (in degrees)
Default	-90
Context	FSI Viewer

Defines the start angle of the rotation around the x-axis. Only relevant if hotspots are used.

armEndAngle	
Description	defines the end angle
Syntax	float (in degrees)
Default	90
Context	FSI Viewer

Defines the end angle of the rotation around the x-axis. Only relevant if hotspots are used.

VirtualSpace Section

The virtualSpace section is optional and only required if you want to verify the 3D projections for use with hot spots. Using the camera parameters, the viewer calculates the position of the hot spots based on the given 3D coordinates only.

cubeSizeX, cubeSizeY and cubeSizeZ	
Description	"cube" is the bounding box of the spin object in millimeters
Syntax	float
Default	-
Context	FSI Viewer

The "cube" is the bounding box of the spin object in millimeters.

cubeLineWidth	
Description	line width of the cube
Syntax	float
Default	-
Context	FSI Viewer

Line width of the drawn cube. Only applies if the parameter "drawCube" is activated.

baseRotationY, baseRotationX, baseRotationZ	
Description	specifies a rotation offset in degrees
Syntax	float
Default	0

baseRotationY, baseRotationX, baseRotationZ

Context	FSI Viewer
---------	------------

You can specify a rotation offset in degrees.

This is required only, if you started the 360° shooting session at an angle other than 0°.

rotationXRange, rotationYRange

Description	specifies the range of the rotation
Syntax	float
Default	180 (X) or 360 (Y)
Context	FSI Viewer

Specifies the range of the rotation of a certain axis.

rotationXSets

Description	defines the initial amount of scene sets
Syntax	integer
Default	number of scene sets
Context	FSI Viewer

Defines the initial amount of scene sets in order to ensure the correct posture of hot spot in case your presentation requires the value in the parameter SceneSets to differ from the initial amount.

rotationYScenes	
Description	defines the initial amount of scenes
Syntax	integer
Default	number of scenes
Context	FSI Viewer

Defines the initial amount of scenes in order to ensure the correct posture of hot spot in case your presentation requires the value in the parameter SceneSets to differ from the initial amount.

shiftX, shiftY and shiftZ	
Description	defines an offset of the spin object on the turn table in mm
Syntax	float
Default	-
Context	FSI Viewer

Optionally defines an offset of the spin object on the turn table in mm.

position	
Description	defines an offset of the spin object on the turn table in mm
Syntax	float
Default	-

position	
Context	FSI Viewer

Alternative parameter to shiftX, shiftY, shiftZ - position(x,y,z) is optional and defines an offset of the spin object on the turn table in mm.

HotSpot Section

The hotspots3d section is optional and only required if you want to display hot spots on your 360° object spin. Hot Spots consist of a marker line and a marker dot as well as content area. The content area may contain all kind of HTML content, e.g. formatted text, hyperlinks, images, videos and alike.

Each hotspot requires an individual hot spot definition node.

In addition a <defaults> node can be used to define default parameter values.

HotSpot definition mode

```

<hotspots3d>
  <defaults>
    <normalClass value="hotspotNormal"/>
    <hoverClass value="hotspotOver"/>
    <activeClass value="hotspotAction"/>
    <perimeterAngleFadeOut value="15" />
  </defaults>
  <hotspot>
    <text value="Hot Spot A "/>
    <x value="11"/>
    <y value="223"/>
    <z value="-116"/>
    <perimeterAngle value="0"/>
    <perimeterAngleRange value="60"/>
  </hotspot>
  <hotspot>
    <text value="Hot Spot B "/>
    <x value="11"/>
    <y value="223"/>
    <z value="-116"/>
    <perimeterAngle value="90"/>
    <perimeterAngleRange value="30"/>
    <perimeterAngleFadeOut value="5" />
  </hotspot>
  [...]

```

Hot Spot Parameters:

x, y and z

Description	x, y, z distance on the real object measured from center of object
-------------	--

x, y and z	
Syntax	float (in mm)
Default	-
Context	FSI Viewer

The x, y and z distance in mm on the real object measured from the center of the object (usually equal to the center of the turn table).

Combined with the required <camera> parameters, the viewer calculates the rotated and projected position of the hot spot on screen.

text	
Description	HTML content to display for this hot spot
Syntax	string
Default	""
Context	FSI Viewer

The HTML content to display for this hot spot.

Note that the value needs to be XML encoded if the content contains invalid characters for XML attribute values (e.g. '&' for '&', '<' for '<', '>' for '>' and '"' for '"').

horizontalMarkerSize	
Description	length of the horizontal line of the hot spot's marker
Syntax	integer

horizontalMarkerSize	
Default	30
Context	FSI Viewer

Length of the horizontal line of the hot spot's marker. Range: [-x ... 0 ... x]

verticalMarkerSize	
Description	length of the vertical line of the hot spot's marker
Syntax	integer
Default	100
Context	FSI Viewer

Length of the vertical line of the hot spot's marker. Range: [0 ... x]

horizontalMarkerPosition	
Description	horizontal position of the marker line
Syntax	float
Default	0
Context	FSI Viewer

Defines the horizontal position of the marker line on the tooltip. Range: [0.0 ... 1.0] The value 0.0 marks the left corner of the tooltip while 1 marks the right corner.

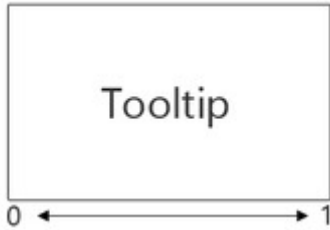

verticalMarkerPosition	
Description	vertical position of the marker line
Syntax	float
Default	0.5
Context	FSI Viewer

Defines the vertical position of the marker line on the tooltip. Range: [0.0 ... 1.0]
The value 0.0 marks the top corner of the tooltip while 1 marks the bottom corner.

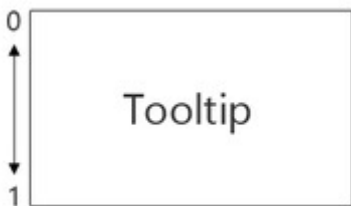

markerAngle	
Description	angle of the vertical hot spot marker
Syntax	float
Default	45
Context	FSI Viewer

Defines the angle of the vertical hot spot marker.

perimeterAngle	
Description	viewing angle in degrees at which to display the hot spot
Syntax	float
Default	-
Context	FSI Viewer

The viewing angle in degrees at which to display the hot spot.

E.g. for a hot spot on the left side of the object use "90".

For a hot spot at the back of the object use "180".

Alias: perimeterAngleY

perimeterAngleX	
Description	viewing angle in degrees at which to display the hot spot
Syntax	float

perimeterAngleX	
Default	-
Context	FSI Viewer

The viewing angle in degrees at which to display the hot spot.

Only applies if a rotation around the x-axis is used.

perimeterAngleRange	
Description	angle range in which the hot spot shall be visible
Syntax	float
Default	30
Context	FSI Viewer

The angle range in which the hot spot shall be visible.

E.g. a perimeterAngle of "90" and a perimeterAngleRange of "40" would display the hot spot from 70 to 110 degrees (+/- 20°).

Alias: perimeterAngleRangeY

perimeterAngleRangeX	
Description	angle range in which the hot spot shall be visible
Syntax	float
Default	30
Context	FSI Viewer

The angle range in which the hot spot shall be visible.

Only applies if a rotation around the x-axis is used.

perimeterAngleFadeOut	
Description	angle range in which the hot spot shall be faded in and out
Syntax	float
Default	10
Context	FSI Viewer

The angle range in which the hot spot shall be faded in and out.

A value of "0" means that the hot spot will be displayed or hidden immediately when entering or leaving the perimeterAngleRange. Values greater than 0 extend the perimeterAngleRange by the given degrees in which the hot spot's opacity changes.

Alias: perimeterFadeOutY

perimeterAngleFadeOutX	
Description	angle range in which the hot spot shall be faded in and out
Syntax	float
Default	10
Context	FSI Viewer

The angle range in which the hot spot shall be faded in and out.

A value of "0" means that the hot spot will be displayed or hidden immediately when entering or leaving the perimeterAngleRange. Values greater than 0 extend the perimeterAngleRange by the given degrees in which the hot spot's opacity changes.

Only applies if a rotation around the x-axis is used.

perimeterZoom	
Description	specifies from which magnification level on a hot spot is displayed
Syntax	float
Default	1.0
Context	FSI Viewer

An optional parameter specifying from which magnification level on a hot spot should be displayed. E.g. 2.5 would hide the hot spot as long as the magnification level is below 2.5. This parameters has no effect if zoom is disabled by the global "enableZoom" parameter.

perimeterImageWidth	
Description	defines the absolute width of spin instance for displaying hot spot
Syntax	float
Default	1.0
Context	FSI Viewer

Similar to perimeterZoom. While perimeterZoom depends on the magnification this parameter defines the absolute width of the (zoomed) spin instance to

decide whether to show or hide a tooltip. It is recommend to set this parameter as a default hot spot parameter when using relative instance sizes.

interactive	
Description	enables or disables reactions of hot spot areas to interactive actions
Syntax	boolean
Default	false
Context	FSI Viewer

The hot spot content area will not react on mouse over, click actions and alike when setting "interactive" to false.

actionParameter	
Description	value will be passed on to the hot spot callback function
Syntax	string
Default	""
Context	FSI Viewer

An optional parameter value that will be passed on to the hot spot callback function.

url	
Description	An optional URL to open if the user clicks the hot spot label.
Syntax	string
Default	""
Context	FSI Viewer

An optional URL to open if the user clicks the hot spot label.

You can use any URL you can use with the `window.open` command, like regular URLs as well as "javascript:" or "email:" URLs.

urlTarget	
Description	target frame or window to open the URL in
Syntax	string
Default	_self
Context	FSI Viewer

The target frame or window to open the URL in.

Use e.g. "_blank" to open hyperlinks in a new window.

focusOnClick	
Description	zoom and/or rotate to hotspot position on click
Syntax	boolean
Default	true

focusOnClick

Context	FSI Viewer
---------	------------

Enables zooming and/or rotating to hotspot position on click.

rotateOnFocus

Description	rotate to sceneSet and scene
Syntax	boolean
Default	true
Context	FSI Viewer

Setting this parameter to true rotates to sceneSet and scene matching the coordinates defined in hotspot.perimeterAngle, while false keeps the current sceneSet and scene.

zoomOnFocus

Description	zoom to hotspot
Syntax	boolean
Default	true
Context	FSI Viewer

Setting this parameter to true zooms to the hotspot, while false keeps the current zoom.

focusRadius	
Description	size of section when zooming to a hotspot
Syntax	float
Default	0.25
Context	FSI Viewer

Defines the size of the section when zooming to a hotspot (0...1).

focusAngleX, focusAngleY	
Description	defines scene with given focus angle (optional)
Syntax	float
Default	-
Context	FSI Viewer

If set, the target scene or sceneSet will not be determined by the perimeterAngle parameter, but with the given focusAngle.

normalClass	
Description	CSS class name to use for content <div> tag in normal state
Syntax	string
Default	"FSI360HotSpot_Normal"
Context	FSI Viewer

A CSS class name to use for the content <div> tag in normal state.

activeClass	
Description	CSS class name to use for content <div> tag in mouse onclick state
Syntax	string
Default	"FSI360HotSpot_Active"
Context	FSI Viewer

A CSS class name to use for the content <div> tag in onclick state.

hoverClass	
Description	CSS class name to use for content <div> tag in mouse over state
Syntax	string
Default	"FSI360HotSpot_Hover"
Context	FSI Viewer

A CSS class name to use for the content <div> tag in mouse over state.

Example CSS classes:

It is recommended to add the following CSS classes to the HTML document containing FSI Viewer instances with hot spots. These classes will be used if you

do not define "normalClass", "hoverClass" and "activeClass" parameters for your hot spots. The `_Mobile` und `_SmallMobile` classes will be added to the hot spot class names on mobile device or small mobile devices (phones). You can use them to adjust the font size to increase the readability of text within the hot spots.

Example CSS classes

```
<style type="text/css">

div.FSI360HotSpot_Normal{
  border:2px solid rgba(255, 255, 0, 0.8);
  font-family:Arial,Helvetica,sans-serif;
  color:#000;
  font-size:13px;
  background: rgba(255, 255, 200, 0.8);
  padding:3px;
  border-radius: 3px;
  cursor:pointer;
  box-shadow: 4px 4px 4px rgba(0,0,0,0.3);
  white-space:nowrap;
}

div.FSI360HotSpot_Active{
  background: #FFF;
}

div.FSI360HotSpot_Mobile{
  font-size:13px;
}

div.FSI360HotSpot_SmallMobile{
  font-size:32px;
}
</style>
```

cssClass	
Description	CSS class name to add to the hot spot's content <div> tag
Syntax	string
Default	""
Context	FSI Viewer

An additional CSS class name to add to the hot spot's content <div> tag.

cssStyle	
Description	CSS style value to add to the hot spot's content <div> tag
Syntax	string
Default	""
Context	FSI Viewer

An additional CSS style value to add to the hot spot's content <div> tag.

Video Section

The video section is optional and only required if you want to enable ultra smooth rotations by providing a video of the spin.

source	
Description	Defines the video source
Syntax	string

source	
Default	""
Context	FSI Viewer

The value may be an absolute URL. Otherwise it will be relative to the [viewer]/applications/spin360/videos/ folder.

 **NOTE:** Just provide the file name WITHOUT the file extension.

Please refer to "[Creating Videos](#)" below for more information on spin videos.

sceneSet	
Description	defines in which Scene Set the video is used
Syntax	string
Default	""
Context	FSI Viewer

If Scene Sets are used, this parameter defines in which Scene Set the video will be used for smooth rotation.

base	
Description	optional prefix for all "source" parameters
Syntax	string
Default	""
Context	FSI Viewer

An optional prefix for all "source" parameters.

spinDirection	
Description	defines the spin direction of the video
Syntax	String "left" or "right"
Default	"left"
Context	FSI Viewer

Defines the spin direction of the video.

You might want to change the spinDirection option if the object spins into the wrong direction when dragging the mouse left or right.

captureFrames	
Description	number of frames to capture from the video
Syntax	integer
Default	120
Context	FSI Viewer

The number of frames to capture from the video.

The more frames you define the smoother the rotation will appear. More frames require more time to capture the videos on startup. 120 frames (default) means 3° per frame.

captureOffsetStart	
Description	offset at start of video to use when capturing the video frames

captureOffsetStart	
Syntax	float (in seconds)
Default	0
Context	FSI Viewer

An optional offset at the start of the video to use when capturing the video frames. You might want to define an offset if the video does not start exactly at the position of the first image (0°).

captureOffsetEnd	
Description	offset at end of video to use when capturing the video frames
Syntax	float (in seconds)
Default	0
Context	FSI Viewer

An optional offset at the end of the video to use when capturing the video frames. You might want to define an offset if the video does not start exactly at the position of the first image (0°).

widthCorrectionFactor	
Description	adjusts width of the video to width of the images on screen
Syntax	float
Default	1.0
Context	FSI Viewer

An optional factor to adjust the width of the video to the width of the images on screen. You might want to adjust the value if the image do not match the video dimension.

heightCorrectionFactor	
Description	adjusts height of the video to height of the images on screen
Syntax	float
Default	1.0
Context	FSI Viewer

An optional factor to adjust the height of the video to the height of the images on screen. You might want to adjust the value if the image do not match the video dimension.

xCorrectionFactor	
Description	adjusts horizontal position of video to horizontal position of images
Syntax	float
Default	0.0
Context	FSI Viewer

An optional factor to adjust the horizontal position of the video to the horizontal position of the images on screen. You might want to adjust the value if the image do not match the video position.

yCorrectionFactor	
Description	adjusts vertical position of video to vertical position of images
Syntax	float
Default	0.0
Context	FSI Viewer

An optional factor to adjust the vertical position of the video to the vertical position of the images on screen. You might want to adjust the value if the image do not match the video position.

frameOffset	
Description	determines a frame offset if required
Syntax	integer
Default	0
Context	FSI Viewer

Determines a frame offset at the start if required.

2.6.2 Plugin Parameters

plugins	
Description	adds a Plug-in (e.g. Fullscreen) to the viewer
Syntax	String
Default	""

plugins	
Context	FSI Viewer

Adds a plug-in to the viewer.



Please note:

If you would like to add specific parameters to the plugins via the fsi-viewer tag, you can do this by prefixing the parameter name with the name of the plug-in, e.g. `autospin_enabled="true"`

FullScreen Plug-In

Adding the parameter `plugins:"FullScreen, Resize"` enables a full screen view option in FSI Viewer. The `Resize` parameter needs to be set in order to ensure proper adjusting to the full screen.



Note:

If the FSI Viewer is embedded in an `iFrame`, the attribute `allowfullscreen="true"` needs to be added to the `iFrame`. Otherwise the FullScreen Plug-in will not work due to security restrictions of the browser.

Resize Plug-In

By adding the parameter `plugins:"Resize"` the plug-in rearranges the user interface according to the size of the object tag without reloading the entire viewer instance and without the need for client side scripting.

MaxZoom Plug-In

By adding the parameter plugins:"maxZoom" expands the user interface by a button to quickly zoom to the physical resolution of the source image.

ZoomMeter Plug-In

Adding the parameter plugins:"ZoomMeter" extends the navigator window with a display of the current magnification.

The following parameters can be set:

zoomMeter	
Description	Enable or disable the text in the navigation window.
Syntax	Boolean
Default	true
Context	FSI Viewer

Enables or disable the text in the navigation window.

zoomMeter_color	
Description	Defines the color of the text in the navigation window
Syntax	color

zoomMeter_color	
Default	-
Context	FSI Viewer

Defines the color of the text in the navigation window.

zoomMeter_decimals	
Description	Number of decimals displayed in the navigation window
Syntax	integer
Default	2
Context	FSI Viewer

Defines the color of the text in the navigation window.

zoomMeter_srcRelative	
Description	Decides how the percentage is displayed
Syntax	boolean
Default	true
	FSI Viewer

Display percentage relative to the source image dimension (true) or relative to the initial image (false).

AutoSpin Plug-In

available from version 16.09.30

Adding the parameter plugins:"AutoSpin" enables a button which lets you play/pause the animation that is set with the autospinspeed parameter. Parameters are listed as the following in the fsi-viewer tag: **autoSpin_Speed**, **mouseModes_MenuOffset**, etc.

The following parameters can be set:

Speed	
Description	Time in seconds for a full rotation
Syntax	float
Default	-
Context	FSI Viewer

Has the same function as "[autoSpinSpeed](#)", but is used here in the context of the plug-in. Time in seconds for a full rotation. Negative values reverse spin direction.

Interval	
Description	Time in seconds for a full rotation
Syntax	float
Default	-
Context	FSI Viewer

Has the same function as "[autoSpinInterval](#)", but is used here in the context of the plug-in.

Can be used instead of `autoSpinSpeed` to define the duration of the `AutoSpin`. `autoSpinInterval` defines the pause between every step of the rotation in ms. Negative values reverse spin direction. The hierarchy of the parameters is as follows:

- `autoSpin_interval` (Plugin Parameter)
- `autoSpinInterval` (Config Parameter)
- `autoSpin_speed` (Plugin Parameter)
- `autoSpinSpeed` (Config Parameter)

preventClickZoomWhileSpinning	
Description	prevents zooming while Autospin is activated
Syntax	Boolean
Default	false
Context	FSI Viewer

Prevents zooming while clicking into the Autospin.

Button	
Description	enables Play/Pause button
Syntax	Boolean
Default	true
Context	FSI Viewer

Enables the Play/ Pause button for the autospin animation

MouseModes Plug-In

The MouseMode plugin is activated by default with the `_default.xml`.





The following parameters can be set:

MenuOffset	
Description	Indentation of the menu buttons
Syntax	Integer
Default	0
Context	FSI Viewer

Specifies the space in pixels left of the menu button(s) of the plug-in.

Mode <i>n</i>	
Description	Removes the button for mouse mode <i>n</i> from the menu bar
Syntax	Boolean
Default	-
Context	FSI Viewer

Provides the possibility to hide specific mouse mode buttons.

Mode n	Mouse Mode
 Mode0	Zoom
 Mode1	Pan
 Mode2	Rotate 3D (X/Y Axis)
 Mode3	Rotate 2D (Z Axis)

Sequence	
Description	Sequence of the buttons
Syntax	String
Default	0,1,3,2
Context	FSI Viewer

You can alter the sequence of the buttons by providing the modes separated by commas (see the table above).

Example: "1,0,2,3" alters the sequence of the buttons to "Pan, Zoom, Rotate 3D, Rotate 2D".

Measure Plug-In

available from version 18.06.25

Adding the parameter `plugins="Measure"` provides an additional button/ mouse-mode which enables the user to measure distances and angles inside the viewer by clicking & dragging. You can list the parameter for the plug-in in the config XML, addressing it with

Example:

```
<plugin src="measure" ImageWidth="2.65" Suffix=" mm" />
```

or you can list the parameters as the following in the `fsi-viewer` tag: ***measure_ImageWidth, measure_Suffix***, etc.

(Provided the parameter `plugins="Measure"` is set in the `fsi-viewer` tag as well)

Pressing SHIFT locks the angle to 45 degree steps. Pressing CTRL moves the measurement line.

Mouse Mode

The mouse mode id for the measuring mode is 100. You can use this id to set the InitialMouseMove parameter of the FSI Viewer. e.g.

```
<InitialMouseMove value="100" />
```

The Measure Plug-in requires the real width of the entire image to enable distance measuring.

Example 1:

If you already know the entire width of the image, simply add the "ImageWidth" and the "Suffix" parameter: If the width of the entire image is 120.5 inches the corresponding tag looks as follows:

Example (defined in Config XML):

```
<plugin src="measure" ImageWidth="120.5" Suffix="inches" />
```

Please note:

You can also define the plugin parameters directly in the fsi-viewer tag, which could look like this:

```
<fsi-viewer width="100%" height="100%" src="images/sample.jpg"
skin="white" plugins="Measure"
measure_ImageWidth="120.5" measure_Suffix=" inches">
```

Example 2:

If you know the width of a part of the image, but you do not know the width of the entire image, you should follow the steps below:

1. Add the measure plug-in without any parameters.
2. Open the image inside the FSIViewer and choose the "Measure" mouse mode.
3. Measure the part of the image you know the real width of. In our example below, we know the width of the notebook is 480mm. The measure plugin will display a value that is our value n.
4. Calculate value w for the ImageWidth parameter:

<ul style="list-style-type: none"> • $w = \text{real length} / n * 100$. • The Measure plug-in displays $n=57.6$ • The real length L of the notebook front is 480 mm. • ImageWidth $w = L / *100 = 480 / 57.6 = 8.33 *100 = 833$ 	
---	---

So the plug-in tag would be defined like this:

Example (defined in Config XML):

```
<plugin src="measure" ImageWidth="833" Suffix=" mm" />
```

**Please note:**

You can also define the plugin parameters directly in the fsi-viewer tag, which could look like this:

```
<fsi-viewer width="100%" height="100%" src="images/
sample.jpg" skin="white"
plugins="Measure" measure_ImageWidth="833"
measure_Suffix=" mm">
```

The plug-in does not support any perspective correction. This means that measuring scanned maps, diagrams will be accurate, measuring 3 dimensional objects is less accurate.

Measure Parameters

The following attributes can be assigned to the tag. You might as well define all plug-in parameters inside the <fsi-viewer> tag by using the prefix "measure_" with the parameter name, e.g. "measure_ ImageWidth".

ImageWidth	
Description	Real width of the entire image
Syntax	Float
Default	100.0
Context	FSI Viewer

Defines the real width of the entire image (e.g. 120 inches). Please see the explanation in the previous section.

Prefix	
Description	Defines a prefix for the length value
Syntax	String
Default	---
Context	FSI Viewer

Defines the prefix for the length value e.g. "length: ".

Suffix	
Description	Defines a suffix for the length value
Syntax	String
Default	mm
Context	FSI Viewer

Defines the suffix for the length value e.g. "inches". Usually this is a length unit.

Initial	
Description	Defines the coordinates of a measure section that is shown initially
Syntax	String
Default	
Context	FSI Viewer

Defines the coordinates of a measure section that is shown initially. Comma separated string containing $x1,y1,x2,y1$ [0..1] coordinates of the image. The values can easily be retrieved using the "arCoords" arguments of the "onMeasureEnd" listener.

ShowInAllMouseModes	
Description	Shows the measurement in all mouse modes
Syntax	Boolean
Default	false
Context	FSI Viewer

Show the measurement in all mouse modes, not just in mouse mode "measure" (100).

Decimals	
Description	Number of decimals of the length value
Syntax	Number
Default	1
Context	FSI Viewer

Defines the number of decimals of the length value.

ShowText	
Description	Display the current measurement string
Syntax	Boolean
Default	true
Context	FSI Viewer

Hides the text displaying the current measurement if set to "false".

ShowAngle	
Description	Display current angle
Syntax	Boolean
Default	true
Context	FSI Viewer

If set to true the plug-in appends a text representing the current angle in degrees to the text display. E.g. "120.2 inches, 43.2°".

LineColor	
Description	Defines the color of the measure lines
Syntax	HexColor
Default	FF0000
Context	FSI Viewer

6-digit hexadecimal color value defining the color of the measure lines.

TextColor	
Description	Defines the color of the text
Syntax	HexColor
Default	000000
Context	FSI Viewer

6-digit hexadecimal color value defining the color of the text.

TextBorder	
Description	Defines the color of the text border
Syntax	HexColor or "false"
Default	000000
Context	Plug-in attribute
Version	FSI Viewer

6-digit hexadecimal color value defining the color of the text border. Use "false" for no border.

TextSize	
Description	Size of the text
Syntax	Number (pixel)
Default	12
Context	FSI Viewer

Text size for the textual output in pixels.

BGColor	
Description	Defines the color of the text background
Syntax	HexColor
Default	FFFFFF
Context	FSI Viewer

6-digit hexadecimal color value defining the background color of the text.

2.7 Creating and using Spin Videos

When creating spin videos for ultra smooth rotations, it is strongly recommended to use a camera that can take photos and record videos so that the position and technical specifications apply to both, the video and the photos.

Make sure you do not modify the object or camera position between the video and photo shooting session.

- I. Take the photos from different viewing angles

2. Record a video of a full, continuous object spin starting at the angle you took the first photo from until reaching the same angle again. You might want to take a video of 2 full spins and cut the video later on.
3. Cut the video if required making sure the video starts and ends at the viewing angle you took the first photo at
4. Export the video in the following formats:
webm (for Chrome, Firefox, Safari, etc.)
mp4 (for MS IE)
5. Copy the video files to a static source connector on FSI Server using the same file names just with the file extension matching the video format
6. Add the <video> section to your configuration file and add the "source" parameter (just the file name WITHOUT the file extension).

2.8 Embedding the viewer at runtime

It is also possible to embed the viewer at runtime via JavaScript.

I) Passing parameters via node attribute:

Example:

```
var node = document.createElement("fsi-viewer");

node.setAttribute("width", "400");
node.setAttribute("height", "600");
node.setAttribute("src", "images/Rocker Shoe.tif");
node.setAttribute("debug", "true");

document.body.appendChild(node);

// Important: required if you add the node AFTER the
// DOMContent has already been loaded
$FSI.initCustomNode(node);
```

II) Passing parameters via JavaScript object:

 **NOTE:** In this case any parameters passed via node attribute will be ignored.

Example:

```

var node = document.createElement("fsi-viewer");
node.style.width = "600px";
node.style.height = "400px";

var parameters =
{"imagesrc" : "images/Rocker Shoe.tif", "skin":"silver",
"debug":true};

$FSI.setParameters(node, parameters);
document.body.appendChild(node);

// Important: required if you add the node AFTER the
DOMContent has already been loaded
$FSI.initCustomNode(node);

```

**Note:**

`$FSI.initCustomNode(node)` initializes the given node.
When adding multiple viewers you can initialize all new FSI Viewer nodes in one go, using this command:
`$FSI.initCustomTag("fsi-viewer");`
or, when using different custom tags (fsi-viewer, fsi-imageflow,...):
`$FSI.initCustomTags();`
to initialize all new FSI custom tags.

Exception if Scripts and HTML Code are loaded dynamically:

⚠ Note:

In case your scripts and HTML Code are loaded dynamically and you cannot ensure correct loading order of the scripts due to CSS (which would lead to a malfunction of the `initCustomTag` function which always needs to be loaded AFTER the viewer script), you can use the following function:

```
function onFSIViewerLoaded(){
  $FSI.initCustomTag('fsi-viewer');
}

window.addEventListener("FSIViewerLoaded",
  onFSIViewerLoaded);
```

The following events are available:

```
FSIViewerLoaded, FSIPagesLoaded, FSITouchZoomLoaded,
FSIQuickZoomLoaded,
FSIImageFlowLoaded, FSIThumbBarLoaded
```

Destroying Instances

Before finally removing `<fsi-viewer>` nodes from the DOM, you need to call the `destroy()` method of the node.

This will release all event handlers and free allocated resources.

Example:

```
var node = document.getElementById("myViewer");

node.destroy();

node.parentNode.removeChild(node);
```

2.9 JavaScript Interface

2.9.1 Public Methods

The JavaScript interface of FSI Viewer can be useful if you want to change the current image or config or add additional content depending on the object spin position or hot spot actions.

void	changeConfig(strCfgFileName, oParameters);
	<p>Reset the viewer object and change the configuration to the given configuration file.</p> <p>strCfgFileName (optional): path to the configuration file (see "cfg" parameter)</p> <p>oParameters (optional): an object containing parameters. If present, these parameters will overwrite the parameters defined upon initialization.</p>

Example:

```

var oParameters = {};
    oParameters.src = "images/bluemarble.tif";
/*
// optional:
oParameters.imageWidth;
oParameters.imageHeight;
oParameters.cropRect;
oParameters.cropValues;
oParameters.effects;
*/

fsiviewer.changeConfig(oParameters);

```

bSuccess	changeImage(cfg, strView);
-----------------	-----------------------------------

ss	
-----------	--

	Resets the viewer object and changes the image displayed to the given image file.
--	---

void	start();
-------------	-----------------

	Starts the viewer.
--	--------------------

void	printAPI();
	Shows all API methods in the console in alphabetical order.

bEnabled	debugEnabled();
	Returns if the debug mode is enabled.

mixed	debugError();
	Returns the corresponding viewer error messages in the console.

mixed	debugLog();
	Returns the corresponding viewer log messages in the console.

mixed	debugWarn();
	Returns the corresponding viewer warning messages in the console.

void	init(elementID, oParameters, bDebug);
	Initialises the chosen viewer element.

mixed	getConfigValue(strName);
	Returns the value of the configuration parameter "strName".

mixed	traceConfigValue(strName);
	Traces a config value and enables you to see where (in config files, the _default.xml, etc) a specific value is set.

blnitDone	getlNitDone();
	Returns if the initialization process is done.

void	spinToDegree(fDegree);
	<p>Spins to the position indicated by degree. Note that you can only spin to a position that has a corresponding HD image, not to a position that shows a video only.</p> <p>fDegree: the desired position in degree (0 .. 360)</p>

void	spinToTarget(nTargetFrame, nStopSceneSet, nFrames);
	<p>Spins to the position indicated by the target parameters.</p> <p>Note that you can only spin to a position that has a corresponding HD image, not to a position that shows a video only.</p>

rcVisibleRect	getVisibleImageRect();
	<p>RETURNS: rcVisibleRect.</p> <p>Returns the Image Rectangle currently visible in FSI Viewer.</p>

strImageRectParameter	getVisibleImageRectParameter();
	<p>RETURNS: strImageRectParam.</p> <p>Returns the Image Rectangle currently visible in FSI Viewer in parameter form.</p>

fZoomAsFloat	getZoomFloat();
	<p>RETURNS: fZoomAsFloat.</p> <p>Returns the current zoom stage as a float value.</p>

strURL	getVisibleImageURL(width, height, strEffects, bMakeImageFitInto);
	<p>RETURNS: strURL.</p> <p>Returns the Image URL exactly as it is currently visible in FSI Viewer.</p> <p>width (default: as in viewer) height (default: as in viewer) effects: optional, ansonsten wie im viewer bMakeImageFitInto: default: false, true => fit image into w x h</p>

nMousemode	getMouseMode();
	Returns the current active mouse mode.

void	setMouseMode(nMode);
	Sets the active mouse mode.

nInstanceID	getInstanceID();
	Returns the number of the viewer object.

strInstanceName	getInstanceName();
	Returns the name of the viewer object.

void	destroy();
	Destroys the given FSI Viewer object. You should destroy the instance before you remove the object spins <code><div></code> tag from the DOM tree.

void	dumpListeners();
	Dumps all listeners.

strVersion	getVersion();
	Returns a string containing the FSI Viewer software version.

strVersion	getBuild();
	Returns a string containing the FSI Viewer software build number.

nHeight	getMenuHeight(strPurpose);
	Returns a string containing the height of the menu bar.

bSuccess	addListener(strListenerName, fn, iScope);
	Calls a specific listener. Listeners which are added via <code>addListener()</code> , remain valid when <code>changeConfig()</code> is called.

bSuccess	removeListener(strListenerName, fn);
	Removes a specific listener.

void	showAboutWindow();
	Shows the "About" window.

void	showMenuButton(strButtonID, bShow);
	Shows a specific menu button.

void	updateSize();
	Updates the size of a fsi-viewer element.

void	resetView();
	Reset the viewer to the initial magnification and rotation.

fZoomInPercent	getZoom();
	Returns the current magnification level, fZoomInPercent [0...100], where fPercent = 0 means normal scale and fPercent = 100 for maximum magnification.

void	setZoom(fPercent, bPreliminary, bAnimate);
	<p>Set magnification to the amount indicated by fPercent [0...100], where fPercent = 0 means normal scale and fPercent = 100 for maximum magnification.</p> <p>bPreliminary: Set to true if the magnification level is temporary only. In this case no additional image data will be loaded. bAnimate: Set to true to animate from the current to the given magnification level.</p>

strViewString	getViewString();
	<p>Returns the string representing the current image section and rotation. The format is: SceneSet, Scene, left, top, right, bottom SceneSet is 1 for rotations around one axis</p> <p>Scene describes the rotation. If you use 36 images for a spin, scene 18 means a rotation of 180 degree.</p> <p>left, top, right, bottom: image coordinates in the range [0.0 to 1.0].</p>

bSuccess	gotoViewString(strViewString, bAnimated);
	<p>Display the image section and rotation as specified by "strViewString".</p> <p>Please refer to the description of the "getViewString" method for a format description.</p> <p>The boolean "bAnimated" can be used to specify, whether the view should be displayed immediately or in form of an animated movement from the current view to the specified view.</p>

strViewString	getHotspotViewString(nHotspotID)
	<p>returns the view string for the given hotspot.</p> <p>FSIHotspotID is the consecutive number of the Hotspot (1,2,3,..)</p>

bSuccess	gotoHotspot(FSIHotspotID, bAnimate, bZoom)
	<p>displays the image section as specified by the Hotspot.</p> <p>FSIHotspotID is the consecutive number of the Hotspot (1,2,3,..)</p> <p>The boolean "bAnimated" can be used to specify, wether the view should be displayed immediately or in form of an animated movement from the current view to the specified view.</p>

bPresent	getMenuButtonPresent(strButtonID)
	<p>Shows active menu buttons, can be used to remove inactive buttons from the menu if you are using a custom skin.</p> <p>NOTE: Method only delivers correct results after the callback "onInItMenu" is called.</p>

void	pressMenuButton(strButtonID)
	Sets the menu button to active.

void	clickMenuButton(strButtonID)
	Sets the menu button to active.

void	releaseMenuButton(strButtonID)
	Disables the active menu button.

void	registerExternalMenuButton(elButton, strButtonID, strTip)
	Registers an external menu button.

void	unregisterExternalMenuButton(elButton)
	Unregisters an external menu button.

void	registerExternalMenuButtonsFromContainer(eIContainer)
	Registers an external menu button from a specific container.

void	unregisterExternalMenuButtonsFromContainer(eIContainer)
	Unregisters an external menu button from a specific container.

strClassName	getSkinClassName()
	Returns the name of the current used skin class, e.g. fsi-skin-black

bFullscreen	getInFullScreenMode()
	Enables the FullScreen mode.

bSuccess	setFullScreenElement(eIFullScreenContainer)
	Defines the FullScreen element.

nFrames	getSpinFrames()
	Returns the amount of spin frames.

bTransparent	getImageIsTransparent()
	Returns the info if the image is transparent.

oDimension	getSrcDim()
	Returns the dimensions of the source image.

void	showMenuToolTip(strTip, elSrc, x, y)
	<p>Shows custom tooltips..</p> <p>strTip: HTML code of the tooltip or ID in language.xml files</p> <p>elSrc: the DOM element which is used to align the tooltip, usually event.target</p> <p>x,y: (optional) offset for tooltip position</p>

void	hideMenuToolTip()
	<p>Shows custom tooltips..</p> <p>strTip: HTML code of the tooltip or ID in language.xml files</p> <p>elSrc: the DOM element which is used to align the tooltip, usually event.target</p> <p>x,y: (optional) offset for tooltip position</p>

oParameters	getParameters();
	<p>Returns an object containing all parameters set via javascript or custom tag attributes.</p>

bResult	makeBoolean(value, bDefaultValue);
	<p>Transforms a value into a boolean value, e.g. "1" to true, "false" to false</p> <p>bDefaultValue is optional and false if not defined.</p>

mixed	getPluginParameter(strPluginName, strParameterName, defaultValue, bMakeBoolean);
	<p>Returns the parameter defined for the given plugin.</p> <p>defaultValue and bMakeBoolean are optional.</p> <p>example: <code>iViewer.getPluginParameter("pages", "dir");</code></p>

void	testAPIListenersStart()
	<p>Starts the API test and shows all called listeners and the parameters which they return.</p>

void	testAPIListenersStop()
	Stops the API test.

bSuccess	startAutoSpin()
	Starts the auto spin.

bSuccess	stopAutoSpin()
	Stops the auto spin.

2.9.2 Callbacks

You can define callback functions by assigning methods to the FSI Viewer instance.

- [Using Callbacks](#)
 - [Method A – Create a function in window scope](#)
 - [Method B - Assignment by parameter](#)
 - [Method C - Assignment by instance property](#)

Using Callbacks

Method A – Create a function in window scope

Example:

```
<script>
  function onFSIViewerViewChanged(strView){
    console.log(strView);
  }
</script>
```

a) assignment in Custom Tag:

Example:

```
<fsi-viewer onViewChanged="onFSIViewerViewChanged" [...] />
```

or

b) assignment in XML configuration file:

Example:

```
<fsi_parameter>  
  <onViewChanged value="onFSIViewerViewChanged"/>  
</fsi_parameter>
```

Method B - Assignment by parameter**Example:**

```
oParameters= {};  
oParameters.onViewChanged = function(strView){  
  console.log(strView);  
}  
  
var myViewer = new $FSI.Viewer(elContainer,  
  oParameters);  
myViewer.start();  
// all callback assignments must take place before  
starting
```

Method C - Assignment by instance property

Example:

```

var myViewer = new $FSI.Viewer(elContainer,
oParameters);
myViewer.onViewChanged = function(strView){
console.log(strView);
}

myViewer.start();
// all callback assignments must take place before
starting

```



Please note: You can modify or add new callbacks when calling `changeConfig()`. You cannot change, add or remove callbacks after the viewer started.

The following callback methods exist:

	onReady();
	Called as soon as FSI Viewer finished loading data and gets interactive.

	onConfigsReady(oConfigValues);
	Called as soon as FSI Viewer finished loading the configuration.

	onInit();
	Called as soon as FSI Viewer is initialized.

	onDestroy();
	Called when the fsi-viewer element is destroyed.

	onInitFailed(strReason);
	Called when the initialization is failed. This could happen if e.g. an image cannot be loaded or the dimensions of an image cannot be requested. The listener returns a string with the reason why the initialization failed.

	onMenuEnabled(bEnabled);
	Called if the menu is enabled/disabled.

	onMenuReady();
	Called as soon as the menu is ready.

	onMenuDestroy();
	Called if the menu is destroyed.

	onZoomChanged(fScale, fScaleMax, fPercent);
	<p>This optional callback function will be called each time the magnification level change is finished.</p> <p>fScale is the magnification level from 0 to 100.</p> <p>fScaleMax sets the maximum zoom level.</p> <p>fPercent is the percentage of the magnification from 0 to 100.</p>

	onZoomChanging(fScale, fScaleMax, fPercent, bPreliminary);
	<p>This optional callback function will be called each time while magnification level changed.</p>

	onAnimationComplete();
	Called when a spin and/or zoom animation finishes.

	onAnimationStart();
	Called when a spin and/or zoom animation starts.

	onChangeConfig(strCfgFileName, oParameters);
	Called when the config file is changed.

	onChangeImage(oParameters, strView);
	Called when the image is changed.

	onResize(nWidth, nHeight, bResizeDone, BFullScreen);
	Called when the fsi-viewer element is resized.

	onSkinChanged(strCurrentSkinClass, strCurrentSkinClassBefore)
	This optional callback function can be used to call an action as soon as the skin class is changed.

	onRegisterExternalMenuButtons()
	This optional callback function can be used to call an action as soon external menu buttons are registered.

	onAfterRegisterExternalButton(elButton, strButtonID, bButtonPresentInViewer)
	This optional callback function can be used to remove inactive buttons from the menu bar if you are using a custom skin.

	onProgress(fPercent);
	This optional callback function can be called while the loading progress.

	onMenuButtonEnabled(strButtonID, null, bEnable);
	This optional callback function can be used call an action when a button is enabled or disabled.

	onMenuButtonPressed(strButtonID, evt);
	This optional callback function can be used to set an action that starts when a button is pressed.

	onMenuButtonReleased(strButtonID, evt);
	This optional callback function can be used to set an action when a certain button is released..

	onMenuButtonClicked(strButtonID, evt);
	This optional callback function can be used to set an action when a certain button is released..

	onMenuButtonSetPressed(bPressed);
	This optional callback function can be used to call an action when a button is pressed.

	onMenuButtonMouseDown(strButtonID, evt);
	This optional callback function can be used to call an action when a mouse button is pressed.

	onReset();
	This optional callback function can be used to call an action when the configuration is changed.

	onAfterReady();
	This optional callback function can be used to call an action after the instance is ready.

	onInitMenu();
	This optional callback function can be used to set an action when the menu is built (after all buttons are added).

	onLanguageData(oLanguageItems);
	This optional callback function can be used to set an action when the language data is loaded.

	onMouseModeChanged(nMouseMode);
	This optional callback function can be used to call an action when the mouse mode is changed.

	onStartDragging(bInNavWindow);
	This optional callback function can be used to call an action when the user starts dragging the image.

	onStopDragging(bInNavWindow);
	This optional callback function can be used to call an action when the user stops dragging the image.

	onDataComplete();
	This optional callback function can be used to call an action while the configuration data loading is completed. Images/videos are not loaded yet at this point.

	onFullScreen(bFullScreenActive);
	This optional callback function can be used to call an action when FullScreen mode is enabled or disabled.

	onViewChanged(strViewString);
	This optional callback function can be used to call an action as soon as the viewed image section changes.

	onClickDemoMode(url, targetFrame);
	This optional callback function can be used to call an action as soon as the demo mode instance is clicked on. (You need to return "false" in order to prevent default action!)

	onEnterDemoMode();
	This optional callback function can be used to call an action as soon as the demo mode is entered.

	onExitDemoMode();
	This optional callback function can be used to call an action as soon as the demo mode is left.

	on3DWorldChanged(o3DDData);
	This optional callback function is called each time the 3D world parameters like rotation or dimension change. oData.projection provides access to the three.js objects (camera, scene, renderer and objects). oData.scenes contains information about the FSI Viewer scenes and scene sets.

	onInit3D(oProjection);
	This optional callback function is called once the three.js scene (camera, scene, renderer and objects) has been created. The oProjection argument provides access to the three.js objects. You might for example add additional 3D objects to oProjection.objects or oProjection.scene.

	onHotspotEvent(strAction, nHotspotID, strHotspotAttributeID, strContent, event)
	This optional callback function can be used to call an action as soon as a certain Hotspot event occurs. The following events are possible: mouseover, mousedown, mouseout & click.

	onMeasureChange(fLength, fRotation, strLabel)
	This optional callback function can be used to call an action as soon the measurement is changed. RETURN: strModifiedLabel

	onMeasureEnd(fLength, fRotation, strLabel, arCoords)
	This optional callback function can be used to call an action as soon as a the measurement ends.

	onMeasureShow(bShow)
	This optional callback function can be used to call an action as soon as the measurement is displayed.

	onMeasureStart(fLength, fRotation, strLabel)
	This optional callback function can be used to call an action as soon as the measurement process is started.

	onMeasureUpdateRatio(fLengthFactor, flmageRealWidth, flmageWidth)
	This optional callback function can be used to call an action as soon as the measurement reference is updated due to a change of the original image ratio.

3 FSI TouchZoom

FSI TouchZoom is an HTML5 and Javascript based tool adding image zoom to touch enabled devices like Apple iPad TM. When pinch zooming into a website containing single source images provided by FSI Server, the images will be displayed in the resolution matching the current magnification.

Supported devices

- iOS 4 or higher
- Android 4.x based devices
- Windows 8 with touch enabled browsers
- Mac OS with touch device

3.1 Usage

To use FSI TouchZoom, make sure the respective images on your website come from FSI Server and add the following script to the <head> section of your website:

Example:

```
<head>  
<script src="viewer/applications/touchzoom/js/  
fsitouchzoom.js" type="text/javascript">  
</script>  
</head>
```

If you would like to use global parameters for all images displayed with FSI TouchZoom, the corresponding parameters can be defined in the `_default.xml`.

Example:

```
<fsi_parameter>
  <Image>
    <ServerType value="FSI"/>
  </Image>

  <TouchZoom>
    <useDevicePixelRatio value="true" />
    <enableByCSSClass value="zoom-image" />
    <zoomPrecision value="3" />
  </TouchZoom>
  ...

  <Options>
    <Skin value="black"/>
    <FSIBase value="config"/>
    <Language value="english"/>
    <ScenePreload value="true"/>
  </Options>

</fsi_parameter>
```

It is possible to pass optional parameters via JavaScript. In this case it is crucial to embed the TouchZoom script before defining the parameters:

Example:

```
<script type="text/javascript
src="/viewer/applications/touchzoom/js/fsitouchzoom.js">
</script>

<script type="text/javascript">
$FSI.touchZoomParameters =
{debug:true, useDevicePixelRatio:false};
</script>
```

Alternatively it is possible to use an external JavaScript for defining the parameters. This is useful if the parameters are valid for multiple HTML documents.

In case the script is automatically initialised (default), the automatically created instance can be addressed via

```
$FSI.touchZoom
```

3.2 Initializing FSI TouchZoom

Initializing or adding images manually

If you are adding images by script, you can decide to:

1) let FSI.TouchZoom initialize automatically and add image manually:

Example:

```
<script type="text/javascript
src="/viewer/applications/touchzoom/js/fsitouchzoom.js">
</script>

<script type="text/javascript">
addMyImagesToTheDom(); // add your images here

// make FSI.TouchZoom look for new images
$FSI.touchZoom.scanForNewImages();
</script>
```

II) initialize FSI.TouchZoom manually after adding your images:

Example:

```

<script type="text/javascript
src="/viewer/applications/touchzoom/js/fsitouchzoom.js">
</script>

<script type="text/javascript">
// prevent $FSI.TouchZoom from initializing
automatically
// on document load
$FSI.touchZoomParameters = {autoInit:false};
function onBodyLoaded() {

    addMyImagesToTheDom(); // add your images here

    // create and initialize FSI.TouchZoom
    var parameters = {debug:true,
useDevicePixelRatio:true};

    myTouchZoom = new $FSI.TouchZoom();
    myTouchZoom.init(parameters);

}
</script>

```

3.3 Parameters

If you would like to use global parameters for all images displayed with FSI TouchZoom, the corresponding parameters can be defined in the `_default.xml`.

Example:

```

<fsi_parameter>
  <Image>
    <ServerType value="FSI"/>
  </Image>

  <TouchZoom>
    <useDevicePixelRatio value="true" />
    <enableByCSSClass value="zoom-image" />
    <zoomPrecision value="3" />
  </TouchZoom>
  ...

  <Options>
    <Skin value="black"/>
    <FSIBase value="config"/>
    <Language value="english"/>
    <ScenePreload value="true"/>
  </Options>

</fsi_parameter>

```

You can optionally modify the way FSI TouchZoom works by passing parameters to the script. To do so, pass an object containing the parameters and value as an object to the constructor:

Example:

```
<script type="text/javascript">
FSITouchZoom = new $FSI.TouchZoom({debug:true,
zoomPrecision:6});
FSITouchZoom.init();
</script>
```

debug

Description	displays debug & status information in the javascript console.
Syntax	Boolean
Default	false
Context	FSI TouchZoom

Display debug and status information in the browser's javascript console.

format

Description	defines the format used for the viewer.
Syntax	Boolean
Default	false
Context	FSI TouchZoom

Defines the format used for the viewer.

Default is auto which automatically chooses the best format depending on the

browser; alternatively you can choose WEBP, JPEG, PNG or GIF.

Auto delivers the images adaptively as WEBP in supporting browsers, and switches to PNG or JPEG on unsupported browsers.

If you set WEBP as a format, please keep in mind that certain browsers (currently Safari and Internet Explorer) do not support the format and will not show the image.

If you would like to use WEBP, the best way would be to set auto as the format.

useDevicePixelRatio	
Description	Use the device's pixel ratio to display even sharper images.
Syntax	Boolean
Default	true
Context	FSI TouchZoom

Use the device's pixel ratio to display even sharper images. For devices with a pixel ratio >1 (e.g. Apple iPad 3) the images will be displayed in higher resolutions. If the aspect ratio is 2, the images loaded when pinching a page will be 2 x the resolution compared to devices with a pixel aspect ratio of 1.

monitorPositions	
Description	The script monitors the position of all single source tags
Syntax	Boolean

monitorPositions	
Default	true
Context	FSI TouchZoom

By default the script monitors the position of all single source `` tags to ensure that a higher resolution image will be loaded if the image is within the viewport. For huge amounts of images on a single web page you might want to disable this feature, if the positions of the images do not change (e.g. there is no javascript modifying the DOM tree).

useTiledImages	
Description	Zoomed images will be tiled into multiple image tiles
Syntax	Boolean
Default	true
Context	FSI TouchZoom

By default, zoomed images of 1000 pixel in width or height will be tiled into multiple image tiles. While this increases the user experience and the loading performance, you might want to disable this feature if you e.g. change the style of an image (e.g. `style.display`) at runtime. In this case the change would not effect the tiled image.

zoomPrecision	
Description	This parameter defines the precision of loading zoomed images.
Syntax	Integer
Default	4
Context	FSI TouchZoom

This parameter defines the precision of loading zoomed images.

Using the value "0" will load images exactly matching the current magnification. This does on the other hand prevent effective caching.

Values greater than 0 increase the precision how often the script loads new images when changing the magnification. The value 4 means that the script loads new images at 1.0, 1.25, 1.5, 1.75, 2.0 etc. magnification levels.

loadingImage	
Description	Specifies which image to display at the bottom right of the viewport
Syntax	Boolean or URL
Default	true
Context	FSI TouchZoom

Specifies whether or which image to display at the bottom right of the viewport while new images are being retrieved from FSI Server. You can use true or false to enable/disable the loading image display or provide an URL to a custom image.

imgSrcAttributeName	
Description	Specifies an alternative image source attribute
Syntax	string
Default	-
Context	FSI TouchZoom

Specifies an alternative image source attribute if required. This is useful for example if your would like to have SEO optimized image URLs in the "src" attribute, which would lead to FSI TouchZoom not recognizing the image. In this case, you can add an alternative image src attribute which contains the FSI Server single source image URL.

enableByCSSClass	
Description	provides a comma separated list of CSS class names
Syntax	String
Default	""
Context	FSI TouchZoom

Using the `enableByCSSClass` parameter you can provide a comma separated list of CSS class names. Only images containing at least one of the given class names will be modified by this script. All other images normal images that do not increase the resolution dynamically.

You can combine this parameter with the `disableByCSSClass` parameter.

disableByCSSClass	
Description	provides a comma separated list of CSS class names
Syntax	String
Default	""
Context	FSI TouchZoom

Using the `disableByCSSClass` parameter you can provide a comma separated list of CSS class names. Images containing at least one of the given class names will NOT be modified by this script. All other images containing single source image URLs will be modified.

You can combine this parameter with the `enableByCSSClass` parameter.

3.4 JavaScript Interface

Usually you will not need to use the javascript interface.

Even if you modify an images `src` parameter at runtime, the tool will notice that and replace the magnified image accordingly.

If you on the other hand add images to the DOM tree at runtime or modify the position of images by script, the following interface is available to update the images and positions:

Initialization:

```
FSITouchZoom = new $FSI.TouchZoom();
FSITouchZoom.init();
```

3.4.1 Public Methods

void	scanForNewImages();
	<p>Calling the scanForNewImages method will make the script look for single source images that have not been present in the DOM tree when the document finished loading. If you e.g. add tags at runtime, you need to call this method in order to make the script aware of new image(s).</p>

void	addImage(ellmg);
	<p>This adds a single node to the list of dynamic touch zoom images. ellmg: the node object</p> <p>Note: you can as well call scanForNewImages() after adding an node.</p>

void	removeImages(arImageDOMElements, bSilent);
	<p>Removes one or more touch zoom images and restores their original state.</p> <p>arImageDOMElements: an node object or an array of node objects</p>

nImagesRemoved	removeAllImages();
	Removes all touch zoom images and restores their original state.

void	updateImagePositions();
	This makes the tool update all image positions and refresh images if needed. You might want to call this after modifying the DOM tree by script.

void	printAPI();
	Shows all API methods in the console in alphabetical order.

mixed	getConfigValue(strName);
	Returns the value of the configuration parameter "strName".

mixed	traceConfigValue(strName);
	Traces a config value and enables you to see where (in config files, the _default.xml, etc) a specific value is set.

void	setZoomPrecision(fPrecision);
	Use this method to modify the parameter zoomPrecision at runtime.

void	destroy();
	Destroys FSI TouchZoom.

void	init();
	Initializes FSI TouchZoom.

strVersion	getVersion();
	Returns a string containing the FSI ImageFlow software version.

strVersion	getBuild();
	Returns a string containing the FSI ImageFlow software build number.

strInstanceName	getInstanceName();
	Returns the name of the viewer object.

nInstanceID	getInstanceID();
	Returns the number of the viewer object.

oParameters	getParameters();
	Returns an object containing all parameters set via javascript or custom tag attributes.

void	enable(bEnable);
	Enables FSI TouchZoom.

nRegisteredImages	getImageCount();
	Returns the amount of registered images available for FSI TouchZoom.

void	lockImage(eImage, bLock);
	Locks a certain image .

void	lockImageSourceDimension(ellImage, bLock);
	Locks a certain image to it's source dimensions.

void	lockUpdates(bLock);
	Locks updates .

void	resetImage(ellmg);
	Resets a certain image.

void	triggerRefresh();
	Triggers a refresh.

bSuccess	addListener(strListenerName, fn, iScope);
	Adds a listener.

bSuccess	removeListener(strListenerName, fn)
	Removes a listener.

void	dumpListeners();
	Dumps all listeners.

void	testAPIListenersStart()
	Starts the API test and shows all called listeners and the parameters which they return.

void	testAPIListenersStop()
	Stops the API test.

3.4.2 Callbacks

void	onConfigsReady(oConfigValues);
	Called when the configuration is ready.

void	onDestroy();
	Called when the instance is destroyed.

void	onInit();
	Called as soon as the viewer is initialized.

void	onZoomChanged(fDocumentScale, fDocumentScalePixelRatio);
	Called as soon as the zoom scope is changed.

4 FSI QuickZoom

FSI QuickZoom is an HTML5 and Javascript based tool adding image zoom to desktop and mobile devices on mouseover or touch. When hovering over a single source image provided by FSI Server, the part of the image the cursor is currently pointing at will be displayed enlarged in a zoom window next to the original image.

Supported devices

- Desktop or laptop computers & all major browsers
- from 19.05: any touchscreen device (mobile & desktop)

4.1 Usage

To use FSI QuickZoom, make sure the respective images on your website come from FSI Server and add the following script to the <head> section of your website:

Example:

```
<head>  
<script src="viewer/applications/quickzoom/js/  
fsiquickzoom.js" type="text/javascript">  
</script>  
</head>
```

If you would like to use global parameters for all images displayed with FSI QuickZoom, the corresponding parameters can be defined in the `_default.xml`.

Example:

```
<fsi_parameter>
  <Image>
    <ServerType value="FSI"/>
  </Image>

  <QuickZoom>
    <useDevicePixelRatio value="true" />
    <enableByCSSClass value="zoom-image" />
    <zoomImageOffset value="10"/>
    <inPlaceZoom value="true"/>
    <moveRangeCenterCorners value="false"/>
  </QuickZoom>
  ...
  <Options>
    <Skin value="black"/>
    <FSIBase value="config"/>
    <Language value="english"/>
    <ScenePreload value="true"/>
  </Options>
</fsi_parameter>
```

It is possible to pass optional parameters via JavaScript. In this case it is crucial to embed the QuickZoom script before defining the parameters:

Example:

```
<script type="text/javascript
src="/viewer/applications/quickzoom/js/fsiquickzoom.js">
</script>

<script type="text/javascript">
$FSI.quickZoomParameters =
{debug:true, useDevicePixelRatio:false};
</script>
```

Alternatively it is possible to use an external JavaScript for defining the parameters. This is useful if the parameters are valid for multiple HTML documents.

In case the script is automatically initialised (default), the automatically created instance can be addressed via

```
$FSI.quickZoom
```

4.2 How FSI QuickZoom works

FSI QuickZoom searches for all `` tags in the HTML document containing FSI Server single source image URLs and adds event handlers to them.

When moving the mouse cursor over these images - or moving the finger over an image on a touch device - a magnified image will be displayed next to the original image. The user can move the cursor across the original image to display any image section of interest.

4.3 Parameters

If you would like to use global parameters for all images displayed with FSI QuickZoom, the corresponding parameters can be defined in the `_default.xml`.

Example:

```
<fsi_parameter>
  <Image>
    <ServerType value="FSI"/>
  </Image>

  <QuickZoom>
    <useDevicePixelRatio value="true" />
    <enableByCSSClass value="zoom-image" />
    <zoomImageOffset value="10"/>
    <inPlaceZoom value="true"/>
    <moveRangeCenterCorners value="false"/>
  </QuickZoom>
  ...
</Options>
  <Skin value="black"/>
  <FSIBase value="config"/>
  <Language value="english"/>
  <ScenePreload value="true"/>
</Options>

</fsi_parameter>
```

It is also possible to pass optional parameters via JavaScript. In this case it is crucial to embed the QuickZoom script before defining the parameters:

Example:

```
<script type="text/javascript"
src="/viewer/applications/quickzoom/js/fsiquickzoom.js">
</script>

<script type="text/javascript">
$FSI.quickZoomParameters = {debug:true,
useDevicePixelRatio:false};
</script>
```

debug

Description	displays debug & status information in the javascript console.
Syntax	Boolean
Default	false
Context	FSI QuickZoom

Display debug and status information in the browser's javascript console.

format

Description	defines the format used for the viewer.
Syntax	Boolean
Default	false
Context	FSI QuickZoom

Defines the format used for the viewer.

Default is auto which automatically chooses the best format depending on the browser; alternatively you can choose WEBP, JPEG, PNG or GIF.

Auto delivers the images adaptively as WEBP in supporting browsers, and switches to PNG or JPEG on unsupported browsers.

If you set WEBP as a format, please keep in mind that certain browsers (currently Safari and Internet Explorer) do not support the format and will not show the image.

If you would like to use WEBP, the best way would be to set auto as the format.

useTouch

Description	activates the zoom function on touch-enabled devices
Syntax	Boolean
Default	true
Context	FSI QuickZoom

Activates the zoom function on touch-enabled devices.

useDevicePixelRatio

Description	Use the device's pixel ratio to display even sharper images.
Syntax	Boolean
Default	true
Context	FSI QuickZoom

Use the device's pixel ratio to display even sharper images. For devices with a pixel ratio >1 (e.g. Apple iPad 3) the images will be displayed in higher resolutions. If the aspect ratio is 2, the images loaded when pinching a page will be 2 x the resolution compared to devices with a pixel aspect ratio of 1.

headers

Description	The "&headers=" parameter to use for image requests.
Syntax	String
Default	"cors"
Context	FSI QuickZoom

The "&headers=" parameter to use for image requests.

imgSrcAttributeName

Description	Specifies an alternative image source attribute
-------------	---

imgSrcAttributeName

Syntax	string
Default	-
Context	FSI QuickZoom

Specifies an alternative image source attribute if required. This is useful for example if you would like to have SEO optimized image URLs in the "src" attribute, which would lead to FSI QuickZoom not recognizing the image. In this case, you can add an alternative image src attribute which contains the FSI Server single source image URL.

enableByCSSClass

Description	provides a comma separated list of CSS class names
Syntax	String
Default	""
Context	FSI QuickZoom

Using the enableByCSSClass parameter you can provide a comma separated list of CSS class names. Only images containing at least one of the given class names will be modified by this script. All other images are displayed as normal images that do not use FSI QuickZoom.

You can combine this parameter with the disableByCSSClass parameter.

disableByCSSClass

Description	provides a comma separated list of CSS class names
-------------	--

disableByCSSClass

Syntax	String
Default	""
Context	FSI QuickZoom

Using the `disableByCSSClass` parameter you can provide a comma separated list of CSS class names. Images containing at least one of the given class names will NOT be modified by this script. All other images containing single source image URLs will be modified.

You can combine this parameter with the `enableByCSSClass` parameter.

addCSSClass

Description	adds an additional CSS class
Syntax	String
Default	""
Context	FSI QuickZoom

Using the `addCSSClass` parameter you can add an additional CSS class. Only images containing the given class names will be modified by this script. All other images are displayed as normal images that do not use FSI QuickZoom.

You can combine this parameter with the `disableByCSSClass` parameter.

magnification

Description	defines the magnification level
Syntax	Float
Default	""
Context	FSI QuickZoom

Defines the magnification level of the image section displayed in the zoom window.

It is also possible to define the magnification for each image tag individually by adding ***FSIQuickZoomMagnification***.

Example:

```
<img FSIQuickZoomMagnification="4" src= [...]>
```

inPlaceZoom

Description	Shows zoom in place of the original image when hovered over
Syntax	Boolean
Default	false
Context	FSI QuickZoom

Show zoomed image instead of the original image when hovered over (true) or show zoom image next to original image (false).

autoZoomDimension

Description	defines on which source the zoom image dimension depends on
Syntax	Boolean
Default	true
Context	FSI QuickZoom

Zoom dimension depends on source image size and screen dimension (true) or zoom dimension corresponds to original image dimension (false).

Setting “inPlaceZoom” to “true” overwrites this parameter to “false”.

moveRangeCenterCorners

Description	defines if corners of the zoom image will be centered
Syntax	Boolean
Default	true
Context	FSI QuickZoom

The zoomed image can be moved until a corner of the image is at the center of the zoom area (true), or the image can only be move until reaching the corner (false).

Setting “inPlaceZoom” to “true” overwrites the default value to “false”.

maxZoomWindowWidth

Description	defines the maximum zoom window width
Syntax	Float
Default	-
Context	FSI QuickZoom

Defines the maximum width of the zoom window displayed next to the original image.

maxZoomWindowHeight

Description	defines the maximum zoom window height
Syntax	Float
Default	-
Context	FSI QuickZoom

Defines the maximum height of the zoom window displayed next to the original image.

minZoomWindowWidth

Description	defines the minimum zoom window width
Syntax	Float
Default	-

minZoomWindowWidth

Context	FSI QuickZoom
---------	---------------

Defines the minimum width of the zoom window displayed next to the original image.

minZoomWindowHeight

Description	defines the minimum zoom window height
Syntax	Float
Default	-
Context	FSI QuickZoom

Defines the minimum height of the zoom window displayed next to the original image.

skipImageWidth

Description	defines minimum image width for QuickZoom use
Syntax	Integer
Default	-
Context	FSI QuickZoom

If the image width is smaller than the width defined with this parameter, FSI QuickZoom will not be applied to it.

skiplImageHeight

Description	defines minimum image height for QuickZoom use
Syntax	Integer
Default	-
Context	FSI QuickZoom

If the image height is smaller than the height defined with this parameter, FSI QuickZoom will not be applied to it.

pageMargin

Description	offset for the zoom window to each side of the page
Syntax	Float
Default	-
Context	FSI QuickZoom

Defines the offset for the zoom window to each side of the page.

zoomImageBorderWidth

Description	defines the image border width
Syntax	Float
Default	-1

zoomImageBorderWidth

Context	FSI QuickZoom
---------	---------------

Defines the image border width of the zoom window.

zoomImageOffset

Description	defines the offset of the zoom window to the original image
Syntax	Float
Default	-1
Context	FSI QuickZoom

Defines the horizontal offset of the zoom window to the original image.

4.3.1 Defining box-shadow and fade-in

The box-shadow and the fade-in of the FSI QuickZoom zoom window can be defined via CSS.

Example:

```
div.FSIQuickZoom {
  border:1px solid #666;
  background-color: white;
  box-shadow: 3px 3px 3px rgba(0,0,0,0.25);
  animation-name: QuickZoomFadeIn;
  animation-duration: 0.5s;
}

@keyframes QuickZoomFadeIn {
  from {
    opacity: 0;
  }
  to {
    opacity: 1;
  }
}
```

4.4 Initializing FSI QuickZoom manually

If you are adding images by script, you can decide to:

I) let FSI.QuickZoom initialize automatically and add image manually:

Example:

```
<script type="text/javascript
src="/viewer/applications/quickzoom/js/fsiquickzoom.js">
</script>

<script type="text/javascript">

addMyImagesToTheDom(); // add your images here

// make FSI.QuickZoom look for new images

$FSI.quickZoom.scanForNewImages();

</script>
```

II) initialize FSI.QuickZoom manually after adding your images:

Example:

```

<script type="text/javascript
src="/viewer/applications/quickzoom/js/fsiquickzoom.js">
</script>

<script type="text/javascript">

// prevent $FSI.QuickZoom from initializing
automatically
// on document load
$FSI.quickZoomParameters = {autoInit:false};

function onBodyLoaded()

{

addMyImagesToTheDom(); // add your images here

// create and initialize FSI.QuickZoom
var parameters = {debug:true, useDevicePixelRatio:true};

myQuickZoom = new $FSI.QuickZoom();
myQuickZoom.init(parameters);

}

</script>

```

4.5 JavaScript Interface

Usually you will not need to use the javascript interface.

Even if you modify an images src parameter at runtime, the tool will notice that and replace the magnified image accordingly.

If you on the other hand add images to the DOM tree at runtime or modify the position of images by script, the following interface is available to update the images and positions:

Initialization:

```
FSIQuickZoom = new $FSI.QuickZoom();
FSIQuickZoom.init();
```

4.5.1 Public Methods

void	init();
	Initializes FSI QuickZoom.

void	printAPI();
	Shows all API methods in the console in alphabetical order.

void	destroy();
	Destroys FSI QuickZoom.

void	addImage(ellmg);
	<p>This adds a single node to the list of dynamic touch zoom images. ellmg: the node object</p> <p>Note: you can as well call scanForNewImages() after adding an node.</p>

void	cancelZoom();
	Cancels the zoom action.

mixed	getConfigValue(strName);
	Returns the value of the configuration parameter "strName".

mixed	traceConfigValue(strName);
	Traces a config value and enables you to see where (in config files, the _default.xml, etc) a specific value is set.

nInstanceID	getInstanceID();
	Returns the number of the viewer object.

strInstanceName	getInstanceName();
	Returns the name of the viewer object.

strVersion	getVersion();
	Returns a string containing the FSI QuickZoom software version.

strBuild	getBuild();
	Returns a string containing the FSI QuickZoom software build number.

nRegisteredImages	getImageCount();
	Returns the amount of registered images.

oParameters	getParameters();
	Returns an object containing all parameters set via javascript or custom tag attributes.

void	removeImages(arImageDOMElements)
	Removes one or more quickzoom images and restores their original state.

void	scanForNewImages();
	Calling the scanForNewImages method will make the script look for single source images that have not been present in the DOM tree when the document finished loading. If you e.g. add tags at runtime, you need to call this method in order to make the script aware of new image(s).

bSuccess	addListener(strListenerName, fn, iScope);
	Adds a listener.

bSuccess	removeListener(strListenerName, fn)
	Removes a listener.

void	dumpListeners();
	Dumps all listeners.

void	testAPIListenersStart()
	Starts the API test and shows all called listeners and the parameters which they return.

void	testAPIListenersStop()
	Stops the API test.

4.5.2 Callbacks

void	onConfigsReady(oConfigValues);
	Called when the configuration is ready.

void	onDestroy();
	Called when the instance is destroyed.

void	onInit();
	Called as soon as the viewer is initialized.

void	onStart(nImagesPrepared, arImageDOMElements);
	Called as soon as the viewer is initialized.

void	onZoomEnd();
	Called as soon as the zooming ends.

void	onZoomStart(ellImage, strZoomImage);
	Called as soon as the zoom is started.

void	onModifyPositionAndSize(oModify, oInfo);
	Returns the position and size.

Example:

```
function setQuickZoomPos(oModify,oInfo){

oModify.left = 0;
// relative to the left of the image's clientRect
oModify.top = 0;
// relative to the top of the image's clientRect

oModify.width = 200;
oModify.height = 200;
oModify.srcZoomImage += "&effects=Sepia()";

// oInfo contains various information you can read
// modifying oInfo does not change anything
// e.g.
// oInfo.elementPosition
(clientPosition of the original
image tag)
// oInfo.imgPaddings (margin and border of the image)

}
```

5 FSI Pages

5.1 Introduction

FSI Pages is a JavaScript based tool for presenting image collections as an interactive catalog, booklet or photo album on desktop computers and mobile devices. FSI Pages automatically creates a page index with thumbnails and supports hyperlinks and interactive zooming.



5.2 How FSI Pages works

The script uses the given `<fsi-pages>` tag, which is similar to an `` tag, to display an interactive catalog.

In the tag, a directory is defined which will contain all images displayed. It is possible to add tooltips and hyperlinks to the pages for displaying product descriptions or to link to an online shop. A chapters plugin enables users to guide through large catalogs easily.

The user can drag the pages left and right to browse through the catalog and zoom in/out either using pinch zoom or by double-clicking on the page.

Hovering over embedded areas displays a tooltip and/or hyperlink if defined.

5.3 Usage of FSI Pages

I) Add the fsipages.js script to the head of your document:

Adding the script:

```
<head>
//adding the fsipages.js script
<script src="viewer/applications/pages/js/fsipages.js"
type="text/javascript"></script>
</head>
```

II) Add a <fsi-pages> tag to the part of your document body where the catalog should be displayed. Add the desired dimension and the image directory to it:

Integrate FSI Pages JS:

```
<body>
<fsi-pages width="100%" height="100%" dir="/images/
catalog/">
//here you can place the fallback content (or image) in
case the browser
// cannot display the viewer, e,g,:
<b>Sorry</b>, your browser is not capable of running FSI
Pages
</fsi-pages>
</body>
```

Parameters are added to the <fsi-pages> tag. Note that you can as well use FSI Pages configuration files:

Adding Parameters to FSI Pages JS:

```
<head>
//adding the fsipages.js script
<script src="viewer/applications/pages/js/fsipages.js"
type="text/javascript"></script>
</head>

<body>

//Adding parameters directly to the tag:
<fsi-pages width="500" height="600" dir="/images/
catalog/" debug="true"
skin="silver" PageLayout="flip">
</fsi-pages>

//Example with using a FSI Pages configuration file:
<fsi-pages width="500" height="600" dir="/images/
catalog/" cfg="sample/catalog.xml">
</fsi-pages>

</body>
```

You can define individual configuration .xml files like this:

Simple Configuration File

```
<fsi_parameter>
  <image>
    <path value="samples/Watch.jpg" />
  </image>
  <Pages>
    <skin value="silver" />
    <debug value="1" />
    <pagelayout value="flip" />
    <thumbsize value="100" />
    <bendeffect value="none" />
  </Pages>
</fsi_parameter>
```

If you would like to use global parameters for all FSI Pages instances, the corresponding parameters can be defined in the `_default.xml`.

Example_default.xml:

```
<fsi_parameter>
  <Image>
    <ServerType value="FSI"/>
  </Image>

  <Pages>
    <skin value="silver" />
    <debug value="1" />
    <pagelayout value="flip" />
    <thumbsize value="100" />
    <bendeffect value="none" />
  </Pages>
  ...
  <Options>
    <FSIBase value="config"/>
    <Language value="english"/>
    <ScenePreload value="true"/>
  </Options>
</fsi_parameter>
```

5.3.1 Defining Image Collections

The images to be displayed in FSI Pages have to be defined in an `<images>` node added to your XML configuration file.

There are two different ways of defining image lists:

Method 1: Retrieving automatically generated image lists from FSI Server

The most convenient way to create image collections is using the template system of FSI Server.

You can do so by using the "Publish to Web" option in FSI Server web interface.

Retrieving Image Collections from Imaging Server:

```
<Pages>  
<ListTemplate value="catalog_list" />  
<dir value="images/catalogs/foo" />  
</Pages>
```

This way FSI Server uses the specified ListTemplate to return the matching images in XML format. Depending on the list template, FSI Server serves IPTC data belonging to an image (e.g. for links) as well. (catalog_list is the default ListTemplate)

Method 2: Creating collections manually using XML configuration files

Creating collections manually using XML configuration files:

```
<Images>
...
<Image file="image1.xml"
label="My First Image" />
<Image file="image2.xml"
label="My Second Image" />
...
</Images>
```

Method I retrieves a complete image list ignoring previously defined <images> nodes.

Image Order

The order of the images (this is the page order) corresponds to the order of the <image> declarations within the <images> section.

Inserting Blank Pages

You can insert blank pages by adding <image empty="true" /> nodes anywhere in your image collection. Alternatively you can use the FSI Pages parameter to pass the page numbers to insert blank pages before separated by commas. This is especially useful if you retrieve the image collection from FSI Server (Method I).

Removing certain Images from a List

Using the parameter [removePages](#) you can disable (remove) certain images from an image list. In this case you pass the page number(s) of the pages you want to remove separated by commas.

5.3.2 Aspect Ratio of the Pages

By default FSI Pages uses the aspect ratio of the first image in the image collection to determine the aspect ratio for all pages.

Alternatively you can manually define an aspect ratio for all pages using the "ratio" parameter.



Examples:

`ratio="1:2"` or `ratio="640:480"`



Note on Aspect Ratio

FSI Pages assumes all images in the given folder will have the same dimensions, thus the first image (cover) is used.

If the following images/pages are having different dimensions (width & height), they may appear distorted.

5.3.3 Presets in FSI Server Interface

You can choose from the following presets when using the "Publish as FSI Pages" option in the FSI Server web interface "Publish To Web" Tab:

- **Catalog with links** Each image represents a page, no page margins, no overlays. If the image contains XML data in the "IPTC_FSI" data field, links will be presented on the page.
- **Catalog without links** Each image represents a page, no page margins, no overlays.
- **Teaser Thumbnail** No user interface, zoom is disabled. Pages flip automatically when idle. You can specify a link for the entire viewer area so that you can use this template to publish a thumbnail of a catalog linking to the full size catalog.

5.3.4 Printing Pages

If you want to enable users to print pages from within FSI Pages you can enable the built-in print function by setting the FSI Pages parameter [Print](#) to "true".

Example:

```
// In the configuration file:

...
<Pages>
<Print value="true" />
<PrintResolution value="1024" />
</Pages>
...

// Directly in the tag :
<fsi-pages dir="..." print="true" ...></fsi-pages>
```

This adds a "Print" button to the menu bar. Clicking the "Print" button displays the "Print" dialog of FSI Pages. The [Print](#) dialog offers different printing options to the user, depending on the current page and if the user zoomed into a page.

The printing options cover:

- Selected Range (e.g. 1-3; 9-20 or 1,6,8,12)
- All pages currently in view
- All pages

After the user has chosen an option and clicks the "Print" button in the dialog, FSI Pages downloads the required image data (pixel data) from the imaging server and opens the print dialog on the user's system once the download has finished.

You can limit the resolution used for printing using the FSI Pages parameter [PrintResolution](#). Lower resolution leads to faster downloads at the cost of decreased print quality.

You can additionally pass effect parameters [PrintEffects](#) to sharpen the image or to specify the image compression.

5.3.5 Saving Pages

If you want to enable users to download a file related to the displayed page, the current section or the entire document, you can enable the save options by setting the FSI Pages parameter [Save](#) to "true".

Example:

```
// In the configuration file:

...
<Pages>
<Save value="true" />
<SaveResolution value="1024" />
</Pages>
...

// Directly in the tag :
<fsi-pages dir="..." save="true" ...></fsi-pages>
```

This adds a "Save" button to the menu bar. Clicking the button displays the "Save" dialog of FSI Pages. Without any additional preparation this allows users to download an image of the left or right page or of both.

After the user has chosen an option and clicks the "Save" button in the dialog, FSI Pages downloads the required image data (pixel data) from the imaging server.

You can limit the resolution used for downloading using the FSI Pages parameter [SaveResolution](#).

You can additionally pass effect parameters [SaveEffects](#) to colorize, pixelize or sharpen the image or to specify the image compression.

Saving a complete PDF

In addition to downloading images you might want to enable users to download the complete source PDF document. This documentation refers to PDF documents only, but you can also provide other file types for download.

Enabling this option is as easy as adding the FSI Pages parameter [SaveDocumentFile](#), providing the absolute URL to a PDF document to download.

Example:

```
// In the configuration file:  
  
...  
<Pages>  
<Save value="true" />  
<SaveResolution value="1024" />  
<SaveDocumentFile value="https://foo.com/file.pdf" />  
</Pages>  
...  
  
// Directly in the tag :  
<fsi-pages save="true" savedocumentfile="https://  
foo.com/file.pdf"></fsi-pages>
```

5.3.6 Special URL Values

For some special URL values FSI Pages ignores the URLPrefixes and URLSuffixes as well. The following table lists these special URLs:

URL	Description
javascript:foo()	Call the JavaScript function foo()
mailto:email@domain.tld	Send an email to email@domain.tld
#none	Do nothing. Handy if you just want to display a tool tip. Available in FSI Pages version 4.0.7 or above
#page=n	Forces FSI Pages to flip to page n
#showimage=[imageURL]	Display a custom JPEG image. The value [URL] needs to be an absolute URL to a JPEG image.
#zoom	Forces FSI Pages to zoom to the area covered by the link's shape(s)
#zoomarea	Magnifies the area covered by the link's shape(s) in place
#zoom=1,1,0,0,0.5,0.5	Forces FSI Pages to zoom to the image area following "="
#zoomonpage=n;strView	Combination of "#page=" and "#zoom=". This is: first flip to page n, then zoom to area strView. Available in FSI Pages version 4.0.7 or above

Please note that the special links starting with "#" need to be provided exactly as listed in the table above. Using e.g. "#zoomOnPage=[...]" or "foo.html#zoom" will link to the HTML anchor provided rather than executing an FSI Pages action.

For "mailto:" URLs the target frame is always "_self", except the XML <area> node specifies a different target.

5.3.7 Creating Intro Content

You can define some HTML Code to be displayed next to the front cover of the publication. This is useful to display e.g. usage instructions.

The content needs to be defined in the <fsi-pages> tag as following:

Example:

```

<head>
[...]
//adding the fsipages.js script
<script src="viewer/applications/pages/js/fsipages.js"
type="text/javascript"></script>
</head>

<body>
[...]
<fsi-pages width="500" height="600" dir="/images/
catalog/" debug="true"
skin="silver" PageLayout="flip" Links="false">

    //Adding intro content:
    <fsi-pages-intro-content>
        <h3>Welcome to our catalog!</h3>
        <br />
        <ul>
            <li>Tap the Next Page/Previous Page
buttons </li>
            <li>Double-click or pinch-zoom on a page
to zoom in</li>
            <li>Tap the full-screen icon to switch
to full-screen mode</li>
            <li>Click on the index icon for a
catalog overview</li>
            <li>Enter a number in the page input
field to browse to a certain page</li>
        </ul>
    </fsi-pages-intro-content>
</fsi-pages>

```

5.4 Parameters

Parameters are added to the `<fsi-pages>` tag. Note that you can as well use FSI Pages configuration files:

Adding Parameters to FSI Pages:

```
<head>
//adding the fsipages.js script
<script src="viewer/applications/pages/js/fsipages.js"
type="text/javascript"></script>
</head>

<body>

//Adding parameters directly to the tag:
<fsi-pages width="500" height="600" dir="/images/
catalog/" debug="true"
skin="silver" PageLayout="flip">
</fsi-pages>

//Example with using a FSI Pages configuration file:
<fsi-pages width="500" height="600" dir="/images/
catalog/" cfg="sample/catalog.xml">
</fsi-pages>

</body>
```

You can define individual configuration .xml files like this:

Simple Configuration File

```
<fsi_parameter>
  <image>
    <path value="samples/Watch.jpg" />
  </image>
  <Pages>
    <skin value="silver" />
    <debug value="1" />
    <pagelayout value="flip" />
    <thumbsize value="100" />
    <bendefect value="none" />
  </Pages>
</fsi_parameter>
```

If you would like to use global parameters for all FSI Pages instances, the corresponding parameters can be defined in the `_default.xml`.

Example_default.xml:

```
<fsi_parameter>
  <Image>
    <ServerType value="FSI"/>
  </Image>

  <Pages>
    <skin value="silver" />
    <debug value="1" />
    <pagelayout value="flip" />
    <thumbsize value="100" />
    <bendeffect value="none" />
  </Pages>
  ...

  <Options>
    <FSIBase value="config"/>
    <Language value="english"/>
    <ScenePreload value="true"/>
  </Options>

</fsi_parameter>
```

You can optionally modify the way FSI Pages works by passing parameters to the script. To do so, pass an object containing the parameters and value as an object to the constructor:

Example:

```

var node = document.createElement("fsi-pages");

node.style.width = "600px";
node.style.height = "400px";

var parameters =
{"dir" : "images/mycatalog/", "skin":"silver", "debug":true};

$FSI.setParameters(node, parameters);
document.body.appendChild(node);

// Important: call this AFTER adding the node to the DOM
$FSI.initCustomNode(node);

```

5.4.1 General Parameters

debug

Description	display debug and status information in the JavaScript console
Syntax	Boolean
Default	false
Context	FSI Pages

Display debug and status information in the browser's JavaScript console.

format	
Description	defines the format used for the viewer.
Syntax	Boolean
Default	false
Context	FSI Pages

Defines the format used for the viewer.

Default is auto which automatically chooses the best format depending on the browser; alternatively you can choose WEBP, JPEG, PNG or GIF.

Auto delivers the images adaptively as WEBP in supporting browsers, and switches to PNG or JPEG on unsupported browsers.

If you set WEBP as a format, please keep in mind that certain browsers (currently Safari and Internet Explorer) do not support the format and will not show the image.

If you would like to use WEBP, the best way would be to set auto as the format.

skin	
Description	defines the skin to display
Syntax	string
Default	"black"
Context	FSI Pages

Defines the skin which will be displayed. FSI Pages comes with three default skins, "black", "white" and "silver".

Skins are defined via CSS and can be found here: </fsi/web/viewer/skins>.

It is also possible to alter existing skins or to define custom skins in this location.

In order to use a custom skin, the easiest way would be to duplicate one of the default skin CSS files and adapt them to your liking. Make sure to use a custom class in front of ALL classes defined in the custom CSS, otherwise you will break other skins on the same HTML document.

To see an example file, please go to the [Appendix](#).

General appearance CSS rules, which are valid on an overall level, (e.g. the logo container, height of the menubar, etc.) are defined in the corresponding core CSS files, which can be found in `/fsi/web/viewer/skins/resources`. (`fsi-core.css`, `fsi-viewer-core.css`)



IMPORTANT:

Never change the classes of the core CSS in the core files directly. If you would like to adapt the CSS rules listed there, please overwrite them in a custom skin file or in the HTML document instead.

You can find detailed tutorials for changing the appearance of the skin in the [support section of our website](#):

- [Create Basic Skins for FSI Viewer JS/ FSI Pages](#)
- [Create Advanced Skins for FSI Viewer JS/ FSI Pages](#)
- [Create Custom Buttons for Skins](#)
- [Create a Custom Skin using JavaScript](#)

For a detailed example of a basic custom skin, please go to "[Example of a custom skin CSS file](#)".

dir	
Description	path to the source images for the catalog on FSI Server
Syntax	String
Default	""
Context	FSI Pages

The path to the source images for the catalog on FSI Server.

The viewer will load the list of images from the given directory.

imageListLimit	
Description	limits the image list to a certain amount of images
Syntax	String
Default	""
Context	FSI Pages

Limits the image list to a certain amount of images within the directory. The parameter is used like this: "0,10" - the first value defines the starting image, the second the amount of images displayed. In this case it would start at the first image and show the first ten images. "5,5" would start the list with the fifth image and shows the fifth image plus the four images that are listed behind it.

imageListSort	
Description	sorts the image list

imageListSort

Syntax	String
Default	"filename"
Context	FSI Pages

Sorts the image list with any valid sort item name for FSI Server. Available sort names:

- "filename" (default)
- "width"
- "height"
- "lastmodified"
- "resolution"
- "importstatus"

imageListSortOrder

Description	defines the order of the image list sorting
Syntax	String
Default	"asc"
Context	FSI Pages

Defines the order of the image list sorting. Possible values: "asc" (Ascending) or "desc" (Descending).

ListFilterPositive

Description	filters the image list using RegEx, includes matching images
-------------	--

ListFilterPositive	
Syntax	String
Default	-
Context	FSI Pages

Filters the image list to a certain amount of images within the directory using RegEx. If images match the Regular Expression, they will be included in the image list. If both ListFilterPositive and ListFilterNegative are used, ListFilterPositive is always used first. The filter will be applied before any other parameter is applied, i.e. all other parameters only apply to the already filtered list.

Example: ListFilterPositive="/\page09\d*.tif/i"

ListFilterNegative	
Description	filters the image list using RegEx, excludes matching images
Syntax	String
Default	-
Context	FSI Pages

Filters the image list to a certain amount of images within the directory using RegEx. If images match the Regular Expression, they will be excluded from the image list. If both ListFilterPositive and ListFilterNegative are used, ListFilterPositive is always used first. The filter will be applied before any other parameter is applied, i.e. all other parameters only apply to the already filtered list.

Example: ListFilterNegative="/\page09\d*.tif/i"

language	
Description	User interface language
Syntax	String
Default	""
Context	FSI Pages

Defines the language of tool tips for the user interface (menu bar).

Possible values depend on the XML based language files located in the sub-index "/languages" of the FSI Viewer setup path. To specify a language, please enter the filename without file extension, e.g. "german".

You can modify existing or add your own "language files".

cfg	
Description	relative path to an XML configuration file in FSI Pages format
Syntax	String
Default	""
Context	FSI Pages

The relative path to an XML configuration file in FSI Pages format.

hideUI	
Description	hides the user interface
Syntax	string
Default	false
Context	FSI Pages

Hides or displays the user interface.

Possible values:	
true	
false	
onMobileDevices:	UI is hidden on mobile devices
ifNoInPlaceZoom:	UI is hidden if in place zoom is deactivated

adaptiveUISize	
Description	determines if interface scales according to the zoom level .
Syntax	Boolean
Default	true
Context	FSI Pages

When set to true, the interface scales according to the zoom level.

Zoom

Description	Enables/ disables page zoom
Syntax	Boolean
Default	true
Context	FSI Pages

Enables/ disables page zoom.

MaxZoom

Description	Maximum zoom in percent of the source image.
Syntax	Float
Default	100
Context	FSI Pages

Maximum zoom in percent of the source image.

OneClickZoom

Description	enables zooming with one click instead of the default double click setting.
-------------	---

OneClickZoom	
Syntax	Boolean
Default	false
Context	FSI Pages

Enables zooming into the catalog with one click instead of the default double click setting.

MenuButtonOrder	
Description	determines the button order in the user interface.
Syntax	string
Default	
Context	FSI Pages

Determines the button order in the menu bar. Use the button ID which can be found in the respective skin.css (viewer\skins\resources\fsi-pages-core.css) for listing them.

Example `MenuButtonOrder="ToggleFullscreen, FirstPage, LastPage"`

Currently the following button IDs exist:

PrintPage, FirstPage, PreviousPage, PageInputEnter, NextPage, LastPage, ToggleBookmarkList, ToggleBookmark, ToggleTableOfContents, TogglePageIndex, ToggleFullScreen

ButtonsFirstLastPage

Description	Enables/ disables First Page and Last Page Buttons
Syntax	Boolean
Default	true
Context	FSI Pages

When set to true, the buttons for directing to the first or the last page appear.

Index

Description	Enables / disables page overview
Syntax	Boolean
Default	true
Context	FSI Pages

Enables or disables the page index containing thumbnails of all pages.

DemoURL

Description	URL to the website that should be opened on click (or alternatively, go to FullScreen)
-------------	--

DemoURL	
Syntax	string
Default	
Context	FSI Pages

The URL to the website that should be opened while clicking on the demo thumbnail. Specifies a link to open when the user clicks anywhere on the FSI Pages instance. This parameter is especially useful when using a small preview of a catalog to lead the user to the full size version of FSI Pages. You can use URLs starting with "javascript:" to have a Javascript function called when the user clicks the viewer.

Alternatively:

- "no action": the click will do nothing at all
- "enter fullscreen" : enter fullscreen and exit demo mode, returns into demo mode after leaving fullscreen mode

DemoURLTarget	
Description	target frame for DemoURL to open in
Syntax	string
Default	"_self"
Context	FSI Pages

HTML frame in which to open the URL specified by "DemoURL" parameter in.

You can use default frame names like "_self" or "_blank" or use a custom frame of your HTML frame set.

HideUIInDemoMode

Description	Hide UI elements in demo mode
Syntax	boolean
Default	true
Context	FSI Pages

Hide UI elements (menu bar and alike) in demo mode.

DemoToolTip

Description	Tool tip to show when in demo mode.
Syntax	string
Default	
Context	FSI Pages

Tool tip to show when in demo mode.

Example for custom HTML:

```
<DemoToolTip>
  <b>Demo Mode</b><br/>
  Click to view image in full screen mode
</DemoToolTip>
```

PageInput	
Description	Enables / disables page input field
Syntax	Boolean
Default	true
Context	FSI Pages

Specifies whether a text box for the page input is displayed in the menu bar.

PageInputEnterButton	
Description	Enables / disables page overview
Syntax	Boolean
Default	true
Context	FSI Pages

Specifies whether the enter button for the page input field is displayed in the menu bar.

ListTemplate

Description	XML based template to use when retrieving image lists from the image server
Syntax	String
Default	"image_list.xml"
Context	FSI Pages

The XML based template to use when retrieving image lists from the image server via "dir" or "query" parameters. Available templates are located in the "WEB-INF/templates/fsi/" directory of your server setup.

PageDataTemplate

Description	XML based template used for the Page Data
Syntax	String
Default	
Context	FSI Pages

The XML based template used for the Page Data.

Print	
Description	Enables or disables the user to print
Syntax	Boolean
Default	true
Context	FSI Pages

Enable or disable the user to print current pages, the complete catalog or specific pages from the image collection shown with FSI Pages.

PrintResolution	
Description	Specifies the print resolution
Syntax	Integer
Default	2000
Context	FSI Pages

Specifies in which resolution the user is allowed to print the pages.

PrintEffects	
Description	Specifies print effects
Syntax	String

PrintEffects

Default	
Context	FSI Pages

Defines image modification parameters to apply to images used for printing.

You can sharpen the image and define the JPEG compression level, e.g. "sharpen=100&quality=95".

Save

Description	Enables or disables the user to save pages
Syntax	Boolean
Default	false
Context	FSI Pages

Enable or disable the download dialog where the user can save the current pages or the complete catalog, depending on the settings.

SaveResolution

Description	Specifies the save resolution
Syntax	Integer
Default	2000

SaveResolution

Context	FSI Pages
---------	-----------

Specifies in which resolution the user is allowed to save the pages.

SaveEffects

Description	Specifies save effects
Syntax	String
Default	
Context	FSI Pages

Defines image modification parameters to apply to images used for saving.

You can sharpen the image and define the JPEG compression level, e.g. "sharpen=100&quality=95".

SaveDocumentFile

Description	URL to entire document (PDF)
Syntax	String
Default	
Context	FSI Pages

If you want to enable the user to save the PDF of your catalog, you can link the URL to the PDF here. This enables the option "complete document" in the download dialog.

Search

Search	
Description	Enable searching a catalog
Syntax	Boolean
Default	false
Context	FSI Pages

Enables or disables the search interface of FSI Pages.

SearchInput	
Description	Shows input for search
Syntax	Boolean
Default	true
Context	FSI Pages

Shows the input for search.

SearchType	
Description	Use "simplesearch" or "search" type for FSI Server
Syntax	String

SearchType	
Default	"simplesearch"
Context	FSI Pages

Using "simplesearch" makes FSI Server search in the data fields "iptc.fsi_search_data" and "iptc.caption" only by default rather than searching in all meta data fields.

SearchContext	
Description	meta data fields to search
Syntax	String
Default	"iptc.fsi_search_data,iptc.caption, iptc.fsi_extra"
Context	FSI Pages

Comma separated list of meta data fields names to search in.FSI Server with FSI Viewer parameter SearchType="simplesearch" only.

SearchAutoWildCards	
Description	Add wildcards ("*") to keywords automatically
Syntax	Boolean
Default	false
Context	FSI Pages

With this parameter, FSI Pages adds wildcards ("*") to the keywords the user entered into the search input of the search dialog. Set this parameter to "false" if you don't want FSI Pages to add wildcards automatically.

SearchAutoSelectFirstResult	
Description	Search Complete Action
Syntax	Boolean
Default	false
Context	FSI Pages

Select the first search result item when the search is complete (true, default) or just show the results (false).

SearchResultClickAction	
Description	Defines action when search result is clicked
Syntax	Enum
Default	flip
Context	FSI Pages

flip:	flip to result page (default
zoom:	zoom the result page

SearchTextOnStart	
Description	Search text on startup
Syntax	String
Default	—
Context	FSI Pages

Define a text to search for on start or an empty string (default) to not initiate a text search on start.

SearchThumbSize	
Description	Thumbnail size of search results
Syntax	Integer
Default	320
Context	FSI Pages

Defines the size of the Search result thumbnails.

SearchParameters	
Description	Adds parameters (modifiers) to the search query
Syntax	String
Default	—
Context	FSI Pages

This parameter provides the possibility to add parameters to the search query within FSI Pages. The parameters need to be provided in the regular HTTP request format: `param1=value1¶m2=value2[...]`.

SearchCustomURL	
Description	URL to request the search result from
Syntax	URL
Default	—
Context	FSI Pages

You can assign a custom URL to direct search requests to using this parameter. For example you might want to use a database and server side script to return pages related to the search request. This is the default way if you are not using imaging server.

SearchResultServerTemplate	
Description	Template for the search result

SearchResultServerTemplate	
Syntax	String
Default	"pages_searchresult" (FSI Server)
Context	FSI Pages

Specifies the server template to request in search queries.

SearchUseMethodGet	
Description	Use HTTP GET method to request search results
Syntax	Boolean
Default	false
Context	FSI Pages

By default FSI Pages requests search results using the HTTP POST method. Using this parameter you can force FSI Pages to use the HTTP GET method when requesting search results.

SearchSortResults	
Description	Sort search results
Syntax	Boolean
Default	True
Context	FSI Pages

If set to true, the search results are ordered by page number.

If set to false, the search results are listed in the order the imaging server sends them to FSI Pages.

5.4.2 Layout/Appearance Parameters

Defines if edge flip is turned off below a certain site width

PageLayout	
Description	Animation when moving to another page
Syntax	String
Default	"flip"
Context	FSI Pages

Defines the animation when moving to another page. "scroll" slides the pages as if they were positioned next to each other (like in FSI Pages mobile). "flip" shows a page turn effect.

NoEdgeFlipBelowWidth	
Description	Defines if edge flip is turned off below a certain page width
Syntax	Integer
Default	-
Context	FSI Pages

Defines if edge flip is turned off below a certain site width. Example: If set to 400, the edge flip is turned off when the page is displayed below 400px. Helpful if you have links to articles on a page near to the edges and want to make sure they can be clicked on smartphones, where usually the edge flip action overlaps.

dropShadow	
Description	Adds a drop shadow underneath double pages.
Syntax	Boolean
Default	true
Context	FSI Pages

Adds a drop shadow underneath double pages. Only applies if PageLayout is set to "flip".

dropShadowOpacity	
Description	Defines the drop shadow opacity.
Syntax	Float
Default	0.3
Context	FSI Pages

Defines the drop shadow opacity. Default is 0.3 from the style sheet class ".fsi-pages-root .fsi-page-drop-shadow ". Any value between 0.0 and 1.0 can be set.

dropShadowDistance

Description	Defines the distance of the drop shadow.
Syntax	Float
Default	50
Context	FSI Pages

Defines the distance of the drop shadow. Default is 50. Any value between 0.0 and 100.0 can be set.

InitialPage

Description	Page to display on startup
Syntax	Integer
Default	1
Context	FSI Pages

Specifies the page to display on startup, e.g. "1" for the front cover.

Ratio

Description	Page to display on startup
Syntax	String
Default	1:1
Context	FSI Pages

The aspect ratio of pages displayed in FSI Pages.

You can specify any aspect ratio (e.g. "320:240" or "1:2") or specify "auto" to use the aspect ratio of the first image in the image collection.

cropRect	
Description	Defines a crop rectangle
Syntax	String
Default	"0,0,1,1"
Context	FSI Pages

Crop rectangle (left, top, right, bottom) as 0.0..1.0 floating point values to display a given section of an image only.

Default: "0,0,1,1"



Note:

You cannot use "CropRect" AND "CropValues" parameters at a time. If you use both, "CropRect" will be ignored.

AutoFlipCropRect	
Description	If active, the right page uses a horizontally flipped crop rect
Syntax	Boolean
Default	true
Context	FSI Pages

If this parameter is enabled, the right page uses a horizontally flipped crop rect. If it is set to false, both pages use the same crop rect.

cropValues	
Description	Defines crop margin values for a page
Syntax	String
Default	"0,0,0,0"
Context	FSI Pages

Defines the amount that should be cut off the image from each side.

Values can be provided as pixel (e.g. "20px") or percent (e.g. "10%") or floating point numbers (e.g. "0.25").

effects	
Description	Image manipulation parameters for all pages
Syntax	String
Default	
Context	FSI Pages

The effects parameter can be used to pass image manipulation parameters to the imaging server. Typical manipulation parameters include the image saturation ("saturation") and image sharpening ("sharpen"). If no effect is specified, the default settings of the server (profile) apply.

Please refer to your FSI Server documentation for a list of available [effect parameters](#).

MousewheelNavigation

Description	defines if navigation with the mousewheel is possible
Syntax	Boolean
Default	true
Context	FSI Pages

Defines if navigation with the mousewheel is possible. If activated, you can turn pages while scrolling with the mousewheel.

ThumbSize

Description	Max. size of thumbnails in the page index
Syntax	Integer
Default	160
Context	FSI Pages

The maximum size of thumbnails displayed in the index. The actual width and height depend on the aspect ratio of the pages.

Parameters only valid if PageLayout is set to scroll:

verticalLayout

Description	moves pages vertical
Syntax	Boolean
Default	"false"
Context	FSI Pages

When set to true, the pages scroll in the vertical direction instead of the usual horizontal.

Note: only valid if PageLayout is set to "scroll"!

onePageInView	
Description	sets only one page in view
Syntax	Boolean
Default	"false"
Context	FSI Pages

Note: only valid if PageLayout is set to "scroll"!

doublePageMode	
Description	enables double page view
Syntax	Boolean
Default	"true"
Context	FSI Pages

If set to "false", the pages will not be displayed as coherent double pages.

autoDoublePageMode	
Description	
Syntax	Boolean

autoDoublePageMode

Default	"true"
Context	FSI Pages

bendEffect

Description	gives pags a glossy bend effect
Syntax	String
Default	"glossy"
Context	FSI Pages

Defines if the pages are shown with a bend effect. "none" disables the effect.

FrontCover

Description	enables/ disables the front cover
Syntax	Boolean
Default	"true"
Context	FSI Pages

Setting "FrontCover" parameter to false disables access to the front cover and forces FSI Pages to display the first image on the first inner left page.

BackCover

Description	Enables/disables the back cover
Syntax	Boolean
Default	"true"
Context	FSI Pages

Setting "BackCover" parameter to false disables access to the back cover and forces FSI Pages to add a blank content page if required.

FrontCoverImage

Description	path to an image to use for the front cover
Syntax	String
Default	-
Context	FSI Pages

A path to an image to use for the front cover. FSI Pages will use the "ImageServer" parameter of FSI Viewer for relative paths.

The cover page(s) will be added to the images in the image list.

BackCoverImage

Description	path to an image to use for the back cover
Syntax	String
Default	-
Context	FSI Pages

A path to an image to use for the back cover. FSI Pages will use the "ImageServer" parameter of FSI Viewer for relative paths.

The cover page(s) will be added to the images in the image list.

BlankBackCover	
Description	Use a blank page for back cover
Syntax	Boolean
Default	"true"
Context	FSI Pages

Use a blank page as back cover.

emptyImages	
Description	add blank pages
Syntax	String
Default	
Context	FSI Pages

Using this parameter you can add blank pages. The value of the parameter must contain one or more image page numbers of the blank pages to be inserted.

E.g. `<EmptyImages value="2,10" />` adds two blank pages at page 2 and page 10, moving the other images in your collection correspondingly.

Alternatively you can add `<image empty="true" />` nodes to your image collection.

removePages

Description	Removes pages from the image collection
Syntax	String
Default	
Context	FSI Pages

Using this parameter you can remove images from the image collection. The behavior of FSI Pages is exactly as if the images would not be listed in the image collection.

E.g. `<EmptyImages value="1,3,4" />` removes the first, third and fourth image in the collection. Please note that removing images takes place before inserting blank pages using the "EmptyImages" parameter.

IdleAutoTurn

Description	Turns pages automatically when idle
Syntax	Boolean
Default	false
Context	FSI Pages

Run the FSI Pages in demonstration mode and turn pages automatically when the user does not interact (= moves the mouse) for 2 seconds.

IdleAutoTurnMinPage

Description	Defines the range for automatical page turning
Syntax	Integer
Default	-

IdleAutoTurnMinPage

Context	FSI Pages
---------	-----------

Loop the auto flip action between IdleAutoTurnMinPage and IdleAutoTurnMaxPage. This way you can restrict the auto flip to a range of pages. If the initial page is outside the range specified, FSI Pages flips towards the range before looping between the range specified.

IdleAutoTurnMaxPage

Description	Defines the range for automatical page turning
Syntax	Integer
Default	-
Context	FSI Pages

Loop the auto flip action between IdleAutoTurnMinPage and IdleAutoTurnMaxPage. This way you can restrict the auto flip to a range of pages. If the initial page is outside the range specified, FSI Pages flips towards the range before looping between the range specified.

IdleAutoTurnDelay

Description	Specifies how long pages are shown when IdleAutoTurn is activated
Syntax	float
Default	2
Context	FSI Pages

Show each page for at least n seconds when flipping pages automatically. Please note that a page might be displayed for longer if loading the page takes longer than the time specified.

PageNumbers	
Description	Display page numbers on pages
Syntax	Boolean
Default	false
Context	FSI Pages

Show or hide page numbers on pages.

FirstPageNumber	
Description	Defines with which page number the catalog starts
Syntax	Integer
Default	1
Context	FSI Pages

Defines with which page number the catalog starts. By default (FirstPageNumber=1) the front cover is page number one.

You can specify an offset so that the page numbers start with a different value.

This parameter affects page numbers, the index and the display of the current page number in the FSI Pages user interface.

UseRomanPageNumbersToPage

Description	Display Roman page numbers up to page number n
Syntax	Integer
Default	0
Context	FSI Pages

Defines the page number up to which FSI Pages uses Roman page Numbers.

The default value of "0" forces FSI Pages to display Roman numbers for negative numbers and 0.

If you set the value to "5" the display will be like this:

I,II,III,IV,V,6,7,8,9...

Note that you can use the Parameter [FirstPageNumber](#) to offset all page number values.

RomanPageNumbersOffset

Description	Offset Roman page numbers by given value
Syntax	Integer
Default	0
Context	FSI Pages

Defines the value of the first Roman page number.

The default value of "0" means no offset so that the Roman numbers start with "I".

CustomPageNumbers

Description	Comma separated string of custom page numbers
Syntax	String
Default	-
Context	FSI Pages

Use "CustomPageNumbers" to specify custom page numbers as a comma separated string. Items starting with underscore ("_") will not be displayed.

Pages without a custom page number will use the ordinary page numbering.

Example: `< CustomPageNumbers value="_cover1,_cover2,3,4,5,_" />`

In this case the cover page and the first left page will have no page number.

The first right page will start with page number "3". The sixth page again has no page number and the seventh and following page will be numbered as usual.

Note: The parameter [FirstPageNumber](#) has no impact on the custom page numbers. You can therefore use this parameter to modify the value of the first ordinary page number.

CustomPageNumbersFile

Description	URL or path to an XML file containing custom page numbers
Syntax	String
Default	-
Context	FSI Pages

Same as CustomPageNumbers, but the page number values will be loaded from an XML file. You can either define a path relative to the `fsi/config/pages_xml/` directory or an absolute URL. The required format of the XML file is as follows:

```
<fsi>
```

```
<pagenumbers>3,6,7</pagenumbers>
```

```
</fsi>
```

RememberLastViewedPage

Description	stores page number and displays page on startup next time
Syntax	Boolean
Default	false
Context	FSI Pages

If you enable this parameter FSI Pages stores the page number of the most recently viewed page on the user's computer and displays this page on start up the next time the user views the same catalogue (image collection) again.

RememberLastViewedPageExpireAfter

Description	defines how long last viewed page will be stored
Syntax	Integer
Default	-
Context	FSI Pages

By default the last viewed page will be restored on the next visit of a user if you enable the `RememberLastViewedPage` parameter. You might want to specify an expire time after that the last viewed page will be discarded. Please specify the expire time in seconds, e.g. "3600" for one hour.

By default, the stored pages will be stored infinitely.

5.4.3 Link Parameters

Links	
Description	Enables/disables links
Syntax	Boolean
Default	true
Context	FSI Pages

Specifies whether links are displayed. If set to "false" Links and tool tips will not be displayed.

linkRGBANormal	
Description	Specifies color & opacity of links in normal state
Syntax	String
Default	"0000FFFF"
Context	FSI Pages

8-digit hexadecimal number specifying the color and opacity of links on the pages in normal state in the form "RRGGBBAA".

linkRGBAHover	
Description	Specifies color & opacity of links in hover state
Syntax	String
Default	"FF00FFFF"

linkRGBAHover

Context	FSI Pages
---------	-----------

8-digit hexadecimal number specifying the color and opacity of links on the pages in hover state in the form "RRGGBBAA".

linkRGBAActive

Description	Specifies color & opacity of links in active state
Syntax	String
Default	"FF00FFFF"
Context	FSI Pages

8-digit hexadecimal number specifying the color and opacity of links on the pages in active state in the form "RRGGBBAA".

FollowLinks

Description	Specifies if links are opened
Syntax	Boolean
Default	true
Context	FSI Pages

Setting this parameter to "false" prevents FSI Pages from opening links on the pages. Links and tool tips will nevertheless be displayed.

LinkTemplates

Description	Template identifiers for link URLs
Syntax	String
Default	-
Context	FSI Pages

You can provide one or more identifiers that will be replaced in Link URLs.

The identifiers are case sensitive and must be separated by commas. The values to insert have to be defined by the parameter "LinkTemplateData" explained below.

LinkTemplateData

Description	Values to replace template identifiers in link URLs
Syntax	String
Default	-
Context	FSI Pages

When defining "LinkTemplates" to replace place holders in Link URLs you can use this parameter to specify the values that shall be inserted. The number and sequence of the values must match the number and sequence of the templates you defined using the "LinkTemplates" parameter.

Multiple values have to be separated by commas and the individual values have to be provided url-encoded.

ForceLinkURL

Description	Force URL for all links on pages
-------------	----------------------------------

ForceLinkURL	
Syntax	String
Default	-
Context	FSI Pages

Force FSI Pages to use this URL for all links on all pages. This overwrites any URLs specified in the page data.

ForceLinkUrlPrefix, ForceLinkUrlSuffix	
Description	Force a link prefix / suffix for all links on pages
Syntax	String
Default	-
Context	FSI Pages

Force FSI Pages to use this prefix /suffix for all links on all pages. This overwrites any prefixes and suffixes specified in the page data.

DefaultLinkURL	
Description	Default URL for links on pages
Syntax	String
Default	-
Context	FSI Pages

Use this URL for links if no URL has been specified in the page data.

DefaultLinkUrlPrefix, DefaultLinkUrlSuffix

Description	Default prefix / suffix for link URLs on pages
Syntax	String
Default	-
Context	FSI Pages

Use this prefix or suffix for all links on the pages if no prefix / suffix has been specified in the page data.

DefaultLinkTarget

Description	Default target frame for all hyperlinks on all pages
Syntax	String
Default	-
Context	FSI Pages

Use this HTML target frame for links if no target frame has been specified in the page XML data.

ForceLinkTarget

Description	Force a target frame for all hyperlinks on all pages
Syntax	String
Default	-
Context	FSI Pages

Force FSI Pages to use this HTML target frame for all links on all pages. Example. "_blank"

This overwrites any target frames specified in the page XML data.

Note: this parameter does not affect "javascript:" and "mailto:" links.

ForceJavascriptTarget	
Description	Force a target frame for all "javascript:" links on pages
Syntax	String
Default	-
Context	FSI Pages

Force FSI Pages to use this HTML target frame for all "javascript:" links on all pages. This overwrites any target frames specified in the page XML data.

Note: this parameter does not affect URL and "mailto:" links.

DefaultJavascriptTarget	
Description	Default target frame for all "javascript:" hyperlinks on all pages
Syntax	String
Default	-
Context	FSI Pages

Use this HTML target frame for "javascript:" links if no target frame has been specified in the page data.

ForceLinkTip	
Description	Force a tool tip for all links on pages

ForceLinkTip

Syntax	String
Default	-
Context	FSI Pages

Force FSI Pages to use this tool tip for all links on the pages. This overwrites any tool tips specified in the page data.

DefaultLinkTip

Description	Default tool tip for links on pages
Syntax	String
Default	-
Context	FSI Pages

Use this tool tip for all links on the pages if no tool tip has been specified in the page data.

5.4.4 Plug-in Parameters

plugins

Description	adds a Plug-in (e.g. Fullscreen) to FSI Pages
Syntax	String
Default	-
Context	FSI Pages

Adds a plug-in to the viewer. Multiple plug-ins can be listed seperated by comma.



Please note:

If you would like to add specific parameters to the plugins via the fsi-pages tag, you can do this by prefixing the parameter name with the name of the plug-in, e.g. `pagesthumbbar_height="100"`

FullScreen

Adding the parameter `plugins:"FullScreen, Resize"` enables a full screen view option in FSI Pages. The `Resize` parameter needs to be set in order to ensure proper adjusting to the full screen.



Note:

If the FSI Pages is embedded in an iFrame, the attribute `allowfullscreen="true"` needs to be added to the iFrame. Otherwise the FullScreen Plug-in will not work due to security restrictions of the browser.

PagesThumbBar

Adding the parameter `plugins:"PagesThumbBar"` displays a row of thumbnails at the bottom of the pages.

The following parameters can be used to adapt the PagesThumbBar:

PageNumbers	
Description	Page numbers being displayed below thumbnails
Syntax	Boolean
Default	true

PageNumbers

Context	FSI Pages
---------	-----------

Enables/ disables the display of page numbers being below the thumbnails.

Autohide

Description	Auto hides thumbar below 600px
Syntax	Boolean
Default	true
Context	FSI Pages

If set to true, the thumbnails will not be displayed if the FSI Pages Instance is smaller than 600px.

Height

Description	Defines height of the thumbnails
Syntax	Integer
Default	160
Context	FSI Pages

Defines the height of the thumbnails displayed.

Bookmarks

Adding the parameter plugins:"Bookmarks" adds a bookmark functionality to FSI Pages.

The following parameters can be used to adapt the bookmarks functionality:

ThumbSize	
Description	Defines the thumbnail size in the bookmark list.
Syntax	Float
Default	200
Context	FSI Pages

Defines the maximum thumbnail size in the bookmark list in pixel.

ShowIconsOnPages	
Description	Shows icon on bookmarked pages
Syntax	Boolean
Default	true
Context	FSI Pages

Shows icon on bookmarked pages.

PageNumbers	
Description	Shows page numbers in bookmark list
Syntax	Boolean
Default	true

PageNumbers

Context	FSI Pages
---------	-----------

Shows page numbers in bookmark list

PersistentStorage

Description	Defines if the bookmark data is being cached..
Syntax	Boolean
Default	true
Context	FSI Pages

When disabled, the bookmarks will be deleted when the user leaves the FSI Pages instance.

When enabled the data will be cached for the given time (defined by PersistentStorageExpiresAfter)

PersistentStorageExpiresAfter

Description	Keep note data for given time.
Syntax	Integer
Default	-
Context	FSI Pages

Defines after which period of time the cached note data expires.

Chapters

Adding the parameter plugins:"Chapters" adds a select box to the user interface of FSI Pages. The user can directly access sections of a catalog by selecting the corresponding item in the select box.

You can either integrate a fsi-pages-chapters node directly in the fsi-pages tag or add an external XML file with your chapters.

Integrating the Chapters structure directly in fsi-pages tag

Example HTML:

```
<fsi-pages
  dir="images/catalog"
  width="100%"
  height="100%"
>
<fsi-pages-chapters style="display:none">
  <chapter page="1">Cover</chapter>
  <chapter page="4">Table of contents</chapter>
  <chapter page="10">
    Chapter 1
    <chapter page="10">Chapter 1.1</chapter>
    <chapter page="20">Chapter 1.2</chapter>
  </chapter>
  <chapter page="30">
    Chapter 2
    <chapter page="30">Chapter 2.1</chapter>
    <chapter page="40">Chapter 2.2</chapter>
  </chapter>
</fsi-pages-chapters>
</fsi-pages>
```

Using an external XMLfile

You can assign colors and different levels to each chapter using simple XML based data describing the document structures.

Example:

```
<Indexdata>
  <Index label="First Page" page="1" color="FFFF00" />
  <Index label="Chapter 1" page="10" color="00FF00">
    <Index label="Chapter 1.1" page="20" color="00FF
00"/>
    <Index label="Chapter 1.2" page="30" color="00FF
00"/>
    <Index label="Chapter 1.3" page="40" color="00FF
00"/>
  </Index>
  <Index label="Chapter 2" page="50" color="0000FF"/>
  <Index label="Chapter 3" page="60" color="CCCCCC"/>
  <Index label="Chapter 4" page="70" color="FF0000"/>
</Indexdata>
```

The following parameters can be used to adapt the Chapters:

indexDataFile	
Description	URL to an external XML file describing the document structure
Syntax	string
Default	-

indexDataFile

Context	FSI Pages
---------	-----------

You can use an external XML file to provide the XML document structure data required for this plug-in. The XML file must be located in the same domain as FSI Viewer to avoid cross-domain security restrictions.

Width

Description	Width of the select box
Syntax	Integer
Default	-
Context	FSI Pages

Usually the FSI Pages skin defines the width and position of the select box. Alternatively you can specify a fixed width in pixels using this parameter.

5.5 JavaScript Interface

The JavaScript interface of FSI Pages can be useful if you - for example - want to set certain actions when FSI Pages is initialized, while pages change, the user interface is used or links are clicked.

5.5.1 Public Methods

void	start();
	Starts FSI Pages.

nID	getInstanceID();
	Returns the ID of the Pages JS object.

strInstanceName	getInstanceName();
	Returns the name of the viewer object.

void id	changeConfig(strCfgFileName, oParameters);
	<p>Reset the viewer object and change the configuration to the given configuration file.</p> <p>strCfgFileName (optional): path to the configuration file (see "cfg" parameter)</p> <p>oParameters (optional): an object containing parameters If present, these parameters will overwrite the parameters defined upon initialization.</p>

void	printAPI();
	Shows all API methods in the console in alphabetical order.

void	init(domElement, oParameters, bDebug);
	Initializes the chosen Pages JS element.

boolean	getInitDone();
	Returns if the initialization process is done.

void	destroy();
	Destroys the given FSI Viewer JS object. You should destroy the instance before you remove the object spins <div> tag from the DOM tree.

boolean	debugEnabled();
	Returns if the debug mode is enabled.

mixed	debugError();
	Returns the corresponding viewer error messages in the console.

mixed	debugLog();
	Returns the corresponding viewer log messages in the console.

mixed	debugWarn();
	Returns the corresponding viewer warning message in the console.

mixed	getConfigValue(strName);
	Returns the value of the configuration parameter "strName".

mixed	traceConfigValue(strName);
	Traces a config value and enables you to see where (in config files, the _default.xml, etc) a specific value is set.

bResult	getConfigBoolean(strParameterName, bDefault);
	Returns the currently configured value of the requested boolean parameter.

fResult	getConfigFloat(strParameterName, fDefault);
	Returns the currently configured value of the requested float parameter.

nResult	getConfigInt(strParameterName, nDefault);
	Returns the currently configured value of the requested integer parameter.

strResult	getConfigString(strParameterName, strDefault);
	Returns the currently configured value of the requested string parameter.

bSuccess	addListener(strListenerName, fn, iScope);
	Calls a specific listener. Listeners which are added via addListener(), remain valid when changeConfig() is called.

bSuccess	removeListener(strListenerName, fn);
	Removes a specific listener..

void	showAboutWindow();
	Shows the "About" window.

void	nextPage();
	Goes to next page.

void	previousPage();
	Goes to previous page.

void	firstPage();
	Goes to first page.

void	lastPage();
	Goes to last page.

bPresent	getMenuButtonPresent(strButtonID)
	<p>Shows active menu buttons, can be used to remove inactive buttons from the menu if you are using a custom skin..</p> <p>NOTE: Method only delivers correct results after the callback "onInitMenu" is called.</p>

void	pressMenuButton(strButtonID)
	Sets the menu button to active.

void	clickMenuButton(strButtonID)
	Sets the menu button to active.

void	releaseMenuButton(strButtonID)
	Disables the active menu button.

void	registerExternalMenuButton(eIButton, strButtonID, strTip)
	Registers an external menu button.

void	unregisterExternalMenuButton(eIButton)
	Unregisters an external menu button.

void	registerExternalMenuButtonsFromContainer(eIContainer)
	Registers an external menu button from a specific container.

void	unregisterExternalMenuButtonsFromContainer(eIContainer)
	Unregisters an external menu button from a specific container.

strClassName	getSkinClassName()
	Returns the name of the current used skin class, e.g. fsi-skin-black

bSuccess	setFullScreenElement(elFullScreenContainer)
	Defines the FullScreen element.

strPageNumber	getCurrentPageNumber()
	Returns the current page number.

strPageNumber	getPageNumberString(nPage)
	Returns the current page number.

oDimension	getPageContainerDim()
	Returns the Page container dimensions.

void	goToPage(strPage, bAnimate)
	Moves to a certain page. strPage is a string and works like the parameter PageInput .

void	goToPageNumeric(nPage, bAnimate)
	Moves to a certain page. Works like goToPageNumber, but with nPage being numeric.

nPage	getTargetPage(nPage)
e	Return the nPage limited to minPage and maxPage. If FSI Pages shows double pages, the value of the left page matching nPage will be returned.

strVersion	getVersion();
	Returns a string containing the FSI Viewer JS software version.

strVersion	getBuild();
	Returns a string containing the FSI Viewer JS software build number.

strContentID	getContentID()
	Returns a string containing the content ID.

void	showMenuToolTip(strTip, elSrc, x, y)
	Shows custom tooltips.. strTip: HTML code of the tooltip or ID in language.xml files elSrc: the DOM element which is used to align the tooltip, usually event.target x,y: (optional) offset for tooltip position

void	hideMenuToolTip()
	<p>Shows custom tooltips..</p> <p>strTip: HTML code of the tooltip or ID in language.xml files</p> <p>elSrc: the DOM element which is used to align the tooltip, usually event.target</p> <p>x,y: (optional) offset for tooltip position</p>

oPageLayoutData	getPageLayoutData()
	<p>oPageLayout has the following properties:</p> <p>boolean bDoublePages</p> <p>int nImages</p> <p>int nMaxPage</p> <p>int nMinPage</p>

oCurrentParameters	getParameters();
	<p>Returns an object containing all current parameters set via javascript or custom tag attributes.</p>

mixed	togglePageIndex();
	Toggles the page index.

bResult	makeBoolean(mixedCOnvert, bDefaultValue);
	<p>Transforms a value into a boolean value, e.g.</p> <p>"1" to true, "false" to false</p> <p>bDefaultValue is optional and false if not defined.</p>

mixed	getPluginParameter(strPluginName, strParameterName, defaultValue, bMakeBoolean);
	<p>Returns the parameter defined for the given plugin.</p> <p>defaultValue and bMakeBoolean are optional.</p> <p>example: <code>iViewer.getPluginParameter("pages", "dir");</code></p>

bSuccess	showSearchDialog(bShow)
	Shows search dialog.

void	gotoPageAndZoom(strPage, strViewstring)
	Goes to a certain page and zooms in.

bSuccess	searchForString(strKeyWords)
	Searches for a string with the given key words..

void	dumpListeners();
	Dumps all listeners.

void	testAPIListenersStart()
	Starts the API test and shows all called listeners and the parameters which they return.

void	testAPIListenersStop()
	Stops the API test.

5.5.2 Callbacks

You can define callback functions by assigning methods to the FSI Pages instance.

The following callback methods exist:

	onReady();
	Called as soon as FSI Pages finished loading data and gets interactive.

	onDestroy();
	Called when the fsi-pages element is destroyed.

	onInitFailed(strReason);
	Called when the initialization is failed. This could happen if e.g. an image cannot be loaded or the dimensions of an image cannot be requested. The listener returns a string with the reason why the initialization failed.

onChangeConfig(strCfgFileName, oParameters);
Called when the config file is changed.

onMenuEnabled(bEnabled);
Called if the menu is enabled/disabled.

onMenuDestroy();
Called if the menu is destroyed.

onMenuButtonEnabled(strButtonID, null, bEnable);
This optional callback function can be used call an action when a button is enabled or disabled.

onMenuButtonPressed(strButtonID, evt);
This optional callback function can be used to set an action that starts when a button is pressed.

onMenuButtonReleased(strButtonID, evt);

This optional callback function can be used to set an action when a certain button is released..

onMenuButtonClicked(strButtonID, evt);

This optional callback function can be used to set an action when a certain button is released..

onMenuButtonSetPressed(bPressed);

This optional callback function can be used to call an action when a button is pressed.

onRegisterExternalMenuButtons()

This optional callback function can be used to call an action as soon as external menu buttons are registered.

onAfterRegisterExternalButton(eIButton, strButtonID, bButtonPresentInViewer)

This optional callback function can be used to remove inactive buttons from the menu bar if you are using a custom skin.

onMenuReady();

This optional callback function can be used to set an action when the menu is ready (after all buttons are added).

onFullScreen(bSet);

This optional callback function can be used to call an action when FullScreen mode is enabled or disabled.

onPageChanged(nPage, strPage, strMaxPage);

This optional callback function can be used to call an action as soon as the viewed page changes.

onShowPageIndex(bShow);
This optional callback function can be used to call an action as soon as the page index is opened.

onShowBookmarkList(bShow);
This optional callback function can be used to call an action as soon as the bookmark list is opened.

onShowChapters(bShow);
This optional callback function can be used to call an action as soon as the chapters opened.

onShowChaptersData(arIndexItems);
This optional callback function can be used to return the Chapters data if the Chapters plugin is implemented (arIndexItems can be multi-dimensional if sub-chapters exist).

onShowPrintDialog(bShow);

This optional callback function can be used to call an action as soon as the print dialog is opened.

onAutoPageLayoutChange(bDoublePage);

This optional callback function can be used to call an action as soon as the page layout is automatically changed.

onPageLayoutChanged(oPageLayoutData);

This optional callback function can be used to call an action as soon as the page layout is manually changed.

onBookmarkAdded(nPage);

This optional callback function can be used to call an action as soon as a bookmark is added to the page.

onBookmarkRemoved(nPage);

This optional callback function can be used to call an action as soon as a bookmark is removed of the page.

onBookmarksLoaded(strLoaded);

This optional callback function can be used to call an action as soon as the bookmarks are loaded.

onBookmarksSaved(strStored);

This optional callback function can be used to call an action as soon as the bookmarks are saved.

onRemoveAllBookmarks();

This optional callback function can be used to call an action as soon as all bookmarks are removed.

onPageSizeChanged(nWidth, nHeight);

This optional callback function can be used to call an action as soon as the page size is changed.

onPageZoomStart(Page, oImageData, oOffset);

This optional callback function can be used to call an action as soon as a page is clicked for zoom (e.g. to call a FSIViewer to be replace the FSI pages for zoom).

onPageZoomed(nPage);

This optional callback function can be used to call an action as soon as the page is zoomed.

onPrintPages(arPageIndices, arImageURLs);

This optional callback function can be used to call an action as soon as the pages are printed.

onPageToolTip(nLinkAreaIndex, strURL, strTipContent);

This optional callback function returns a string that is useful if you want to modify the tool tip content. Returns: strModifiedToolTipContent

onOpenPageLink(nLinkAreaIndex, strURL, strTarget);

This optional callback function can be used to call an action if links are clicked. Return "false" to prevent opening the link., return {strURL:"foo", strTarget: "bar"} to modify the URL or the target (both are optional)

onResize(nWidth, nHeight, bResizeDone, BFullScreen);

Called when the fsi-pages element is resized.

onSkinChanged(strCurrentSkinClass, strCurrentSkinClassBefore)

This optional callback function can be used to call an action as soon as the skin class is changed.

onSearchInit(eInput)

This optional callback function can be used to call an action as soon as the search is initialized.

onSearchResults(arPageNumbers, arImages)

This optional callback function can be used to call an action as soon as the search results are returned.

onSearchStart(strKeyWords, strInput)

This optional callback function can be used to call an action as soon as the search is started.

onClickDemoMode(url, targetFrame);

This optional callback function can be used to call an action as soon as the demo mode instance is clicked on. (You need to return "false" in order to prevent default action!)

	onEnterDemoMode();
	This optional callback function can be used to call an action as soon as the demo mode is entered.

	onExitDemoMode();
	This optional callback function can be used to call an action as soon as the demo mode is left.

	onShowSaveDialog(bShow)
	This optional callback function can be used to call an action as soon as the save dialog is showed.
	onShowSearchDialog(bShow)
	This optional callback function can be used to call an action as soon as the search dialog is showed.
	onGetChaptersData(nodeChaptersData)
	This optional callback function can be used to call an action as soon as the chapters data is loaded.

onGetIntroContent(nodeIntroData)
This optional callback function can be used to call an action as soon as the intro content is loaded.
onLinkHover(oLinkData, bHover)
This optional callback function can be used to call an action as soon as the cursor hovers over the link.

6 FSI ThumbBar

FSI ThumbBar is a Javascript based image thumb bar with optional image zoom.

Supported devices test

- iOS 4 or higher
- Android 4.x based devices
- Windows 8 with touch enabled browsers
- Mac OS with touch device

6.1 Usage

I) Add the fsithumbbar.js script to the head of your document:

Example:

```
<head>  
<script src="viewer/applications/thumbbar/js/  
fsithumbbar.js" type="text/javascript">  
</script>  
</head>
```

II) Add a `<fsi-thumbbar>` tag to the part of your document body where FSI ThumbBar should be displayed. Add the desired dimension to it and image source (directory) to it:

Example:

```
<body>
<fsi-thumbbar width="400" height="150" dir="/images/
foo/" >
</fsi-thumbbar>
</body>
```

Parameters are added to the `<fsi-thumbbar>` tag. Note that you can as well use configuration files:

Example:

```
<body>

//Adding parameters directly to the tag:
<fsi-thumbbar width="100%" height="150" src="/images/
foo/"
backgroundcolor="#000" presentationtype="flat">
</fsi-thumbbar>

//Example with using a FSI configuration file:
<fsi-thumbbar width="100%" height="150" dir="/images/
foo/" cfg="sample/sample_configuration>
</fsi-thumbbar>

</body>
```

You can define individual configuration .xml files like this:

Simple Configuration File

```
<fsi_parameter>
  <image>
    <path value="samples/Watch.jpg" />
  </image>
  <ThumbBar>
    <presentationtype value="stacks" />
    <debug value="1" />
    <enablezoom value="false" />
    <preloadcount value="8" />
  </ThumbBar>
</fsi_parameter>
```

If you would like to use global parameters for all FSI ThumbBar instances, the corresponding parameters can be defined in the `_default.xml`.

Example_default.xml:

```

<fsi_parameter>
  <Image>
    <ServerType value="FSI"/>
  </Image>

  <ThumbBar>
    <presentationtype value="stacks" />
    <debug value="1" />
    <enablezoom value="false" />
    <preloadcount value="8" />
  </ThumbBar>
  ...
  <Options>
    <FSIBase value="config"/>
    <Language value="english"/>
    <ScenePreload value="true"/>
  </Options>

</fsi_parameter>

```

6.2 How FSI ThumbBar works

The script retrieves an image list from FSI Server and display the images in form of an image thumbbar in the given <fsi-thumbbar> tag.

⚠ Note on Internet Explorer:

In order to make FSI ThumbBar work, Internet Explorer must run in IE8 quirks, IE9 or higher quirks or standards mode. You can ensure that by adding an X-UA-Compatible meta tag to the head section of your web page, for example:

```
<meta http-equiv="X-UA-Compatible"
content="IE=Edge,chrome=1">
```

6.3 Parameters

Parameters are added to the `<fsi-thumbbar>` tag. Note that you can as well use configuration files:

Example:

```
<body>

//Adding parameters directly to the tag:
<fsi-thumbbar width="100%" height="150" src="/images/
foo/"
  backgroundcolor="#000" presentationtype="flat">
</fsi-thumbbar>

//Example with using a FSI configuration file:
<fsi-thumbbar width="100%" height="150" dir="/images/
foo/"
  cfg="sample/sample_configuration">
</fsi-thumbbar>

</body>
```

You can define individual configuration .xml files like this:

Simple Configuration File

```
<fsi_parameter>
  <image>
    <path value="samples/Watch.jpg" />
  </image>
  <ThumbBar>
    <presentationtype value="stacks" />
    <debug value="1" />
    <enablezoom value="false" />
    <preloadcount value="8" />
  </ThumbBar>
</fsi_parameter>
```

If you would like to use global parameters for all FSI ThumbBar instances, the corresponding parameters can be defined in the `_default.xml`.

Example_default.xml:

```
<fsi_parameter>
  <Image>
    <ServerType value="FSI"/>
  </Image>

  <ThumbBar>
    <presentationtype value="stacks" />
    <debug value="1" />
    <enablezoom value="false" />
    <preloadcount value="8" />
  </ThumbBar>
  ...
  <Options>
    <FSIBase value="config"/>
    <Language value="english"/>
    <ScenePreload value="true"/>
  </Options>
</fsi_parameter>
```

You can optionally modify the way FSI ThumbBar works by passing parameters to the script. You can either use an XML configuration passing the path using a "cfg" parameter or pass parameters and values as an object to the constructor:

Example:

```
<script type="text/javascript">
thumb = new $FSI.ThumbBar({debug:true,
backgroundColor:"#ff0"});
thumb.init();
</script>
```

debug

Description	displays debug & status information in the javascript console.
Syntax	Boolean
Default	false
Context	FSI ThumbBar

Display debug and status information in the browser's JavaScript console.

format

Description	defines the format used for the viewer.
Syntax	Boolean
Default	false
Context	FSI ThumbBar

Defines the format used for the viewer.

Default is auto which automatically chooses the best format depending on the browser; alternatively you can choose WEBP, JPEG, PNG or GIF.

Auto delivers the images adaptively as WEBP in supporting browsers, and switches to PNG or JPEG on unsupported browsers.

If you set WEBP as a format, please keep in mind that certain browsers (currently Safari and Internet Explorer) do not support the format and will not show the image.

If you would like to use WEBP, the best way would be to set auto as the format.

headers	
Description	header parameter to use for image requests
Syntax	String
Default	"cors"
Context	FSI ThumbBar

The "&headers=" parameter to use for image requests.

The default value "cors" ensures cors compatibility for cross-origin scenarios.

dir	
Description	The path to the source image folder on FSI Server to display.
Syntax	string
Default	""
Context	FSI ThumbBar

The path to the source image folder on FSI Server to display.

imageListLimit

Description	limits the image list to a certain amount of images
Syntax	String
Default	""
Context	FSI ThumbBar

Limits the image list to a certain amount of images within the directory. The parameter is used like this: "0,10" - the first value defines the starting image, the second the amount of images displayed. In this case it would start at the first image and show the first ten images. "5,5" would start the list with the fifth image and shows the fifth image plus the four images that are listed behind it.

imageListSort

Description	sorts the image list
Syntax	String
Default	"filename"
Context	FSI ThumbBar

Sorts the image list with any valid sort item name for FSI Server. Available sort names:

- "filename" (default)
- "width"
- "height"
- "lastmodified"
- "resolution"
- "importstatus"

imageListSortOrder	
Description	defines the order of the image list sorting
Syntax	String
Default	"asc"
Context	FSI ThumbBar

Defines the order of the image list sorting. Possible values: "asc" (Ascending) or "desc" (Descending).

ListFilterPositive	
Description	filters the image list using RegEx, includes matching images
Syntax	String
Default	-
Context	FSI ThumbBar

Filters the image list to a certain amount of images within the directory using RegEx. If images match the Regular Expression, they will be included in the image list. If both ListFilterPositive and ListFilterNegative are used, ListFilterPositive is always used first. The filter will be applied before any other parameter is applied, i.e. all other parameters only apply to the already filtered list.

Example: ListFilterPositive="/\09\d*.tif/i"

ListFilterNegative	
Description	filters the image list using RegEx, excludes matching images
Syntax	String
Default	-
Context	FSI ThumbBar

Filters the image list to a certain amount of images within the directory using RegEx. If images match the Regular Expression, they will be excluded from the image list. If both ListFilterPositive and ListFilterNegative are used, ListFilterPositive is always used first. The filter will be applied before any other parameter is applied, i.e. all other parameters only apply to the already filtered list.

Example: ListFilterNegative="/\09\d*.tif/i"

renderer	
Description	The renderer parameter to use for image requests (e.g. jpeg).
Syntax	string
Default	""
Context	FSI ThumbBar

The renderer parameter to use for image requests (e.g. jpeg).

format	
Description	The format parameter to use for image requests (e.g. png).
Syntax	string
Default	""
Context	FSI ThumbBar

The format parameter to use for image requests (e.g. png).

overlays	
Description	The overlays parameter to use for image requests.
Syntax	string
Default	""
Context	FSI ThumbBar

The overlays parameter to use for image requests.

quality	
Description	JPEG quality level when retrieving JPEG images from the server.
Syntax	Integer
Default	-

quality

Context	FSI ThumbBar
---------	--------------

The JPEG quality level when retrieving JPEG images from the server.

effects

Description	Optional FSI Server effects to use for all images.
Syntax	String
Default	""
Context	FSI ThumbBar

Optional FSI Server effects to use for all images.

Example: `effects:"Sepia()"`

In contrast to all other parameters, defining the parameter "effect" adds(!) the string to the existing effects parameter.

E.g. if your configuration file contains: `<effects value="blur(10)" />` and you add to your `<fsi-viewer>` tag `effects="sepia()"`, the resulting effects parameter value is: `blur(10),sepia()`.

If you want to overwrite existing effects values, you can start the effects parameter with `"ClearEffects()"`.

In the example above, if you add `effects="ClearEffects(),sepia()"` to your `<fsi-viewer>` tag, the resulting effects parameter value is `"sepia()"` only.

**Please note:**

ClearEffects() must be written exactly like this and must be at the start of the "effects" parameter value.

Please refer to your [FSI Server documentation](#) for a list of available effect parameters.

cropValues	
Description	Defines the amount that should be cut off the image.
Syntax	String
Default	""
Context	FSI ThumbBar

Defines the amount that should be cut off the image from each side.

Values can be provided as pixel (e.g. "20px") or percent (e.g. "10%") or floating point numbers (e.g. "0.25").

Use 4 values for left, top, right, bottom.

Example: 10%,0,10%,0

cropRect	
Description	Defines a crop rectangle
Syntax	String
Default	"0,0,1,1"
Context	FSI ThumbBar

Defines the amount that should be cut off the image from each side.

Values can be provided as pixel (e.g. "20px") or percent (e.g. "10%") or floating point numbers (e.g. "0.25").

Use 4 values for left, top, right, bottom.



Note

You cannot use "CropRect" AND "CropValues" parameters at a time. If you use both, "CropRect" will be ignored.

elementWidth	
Description	The maximum width of images in the slideshow.
Syntax	String
Default	10 (px)
Context	FSI ThumbBar

The maximum width of images in the slideshow. The value can be provided in pixels or in percent of the instance width.

minelementWidth	
Description	The minimum width of images in the slideshow.
Syntax	Integer
Default	24
Context	FSI ThumbBar

The minimum width of images in the slideshow. The value can be provided in pixels or in percent of the instance width.

elementSpacing	
Description	Spacing between the images in pixel.
Syntax	String
Default	0.25 (%)
Context	FSI ThumbBar

Spacing between the images in pixel. The spacing needs to be either stated in pixels or in percent of the instance width.

Note: If the resulting image height limits the image dimension, there is a spacing even if you define elementSpacing with a value of "0". In this case you either need to:

- a) Increase the container `<div>` element height
- b) Decrease the value of the elementWidth parameter

minElementSpacing

Description	Minimum spacing between the images in pixel.
Syntax	Integer
Default	0
Context	FSI ThumbBar

Minimum spacing between the images in pixel. The spacing needs to be either stated in pixels or in percent of the instance width.

autoElementSpacing

Description	adjusts the spacing automatically
Syntax	Boolean
Default	true
Context	FSI ThumbBar

If set to "true" and all thumbnails fit into view and there is more than one thumbnail, the elementSpacing will be adjusted so that the first thumbnail is left aligned and the last thumbnail is right aligned, with even spacing between the rest of the thumbnails.

containerAlignment

Description	alignment of the image container
Syntax	string
Default	center

containerAlignment

Context	FSI ThumbBar
---------	--------------

Defines the alignment of the image container if there are less images than fitting into the element.

Only applicable to `presentationType="flat"` and if `autoElementSpacing="false"`. Default is "left". You can either set "center" or "0.5" to center the image container, or set a number between 0-1 for more specific alignment.

paddingTop

Description	Top padding in pixel.
Syntax	Integer
Default	10
Context	FSI ThumbBar

Top padding in pixel.

paddingBottom

Description	Bottom padding in pixel.
Syntax	Integer
Default	0
Context	FSI ThumbBar

Bottom padding in pixel.

autoResize	
Description	defines if instance is resized when the DOM element is resized
Syntax	Boolean
Default	true
Context	FSI ThumbBar

Defines if the instance is resized when the DOM element is resized.

initialImage	
Description	defines the image index to focus on start
Syntax	Integer
Default	0
Context	FSI ThumbBar

Defines the image index to focus on start.

vertical	
Description	defines if the thumb bar is displayed horizontally or vertically

vertical	
Syntax	Boolean
Default	false
Context	FSI ThumbBar

Defines if the thumb bar is displayed horizontally (default) or vertically.

presentationType	
Description	The overall image presentation appearance.
Syntax	String
Default	"flat"
Context	FSI ThumbBar

Selects the overall image presentation appearance in FSI ThumbBar. Available types:

- "flat"
- "stacks"
- "outerRing"
- "innerRing"
- "custom" (see chapter "[Using custom presentation type](#)")

enableZoom	
Description	Enable or disable zooming the focused image with the built-in image zoom.

enableZoom	
Syntax	Boolean
Default	true
Context	FSI ThumbBar

Enable or disable zooming the focused image with the built-in image zoom.

When zooming an image, FSI ThumbBar adds a `<div>` element to the document body, holding the zoomed image.

useTouchZoom	
Description	Uses FSI TouchZoom on thumbnail images.
Syntax	Boolean
Default	true
Context	FSI ThumbBar

Uses FSI TouchZoom on thumbnail images and requires adding the FSI TouchZoom script to the document.

zoomMargin	
Description	Sets margin around the zoom div.
Syntax	Integer
Default	40
Context	FSI ThumbBar

Defines the margin around the zoom div (when not using FSI Viewer).

ScrollBar	
Description	enable or disable the scroll bar.
Syntax	Boolean
Default	true
Context	FSI ThumbBar

This value enables or disables the scroll bar.

centerZoomedImage	
Description	scrolls to the selected (zoomed) image
Syntax	Boolean
Default	true
Context	FSI ThumbBar

Moves the currently zoomed image to the center of the bar.

Alignment	
Description	Alignment of the thumbnails (vertical alignment if horizontal thumb bar and vice versa).

Alignment	
Syntax	Float
Default	1.0
Context	FSI ThumbBar

Usually, the alignment is done via CSS.

To use CSS, please set the "Alignment" parameter to "false" and use these CSS classes:

Example:

```
// for horizontal alignment
fsi-thumbbar .fsi-thumbbar-container .fsi-thumbbar-
thumbnail{
text-align: center;
}
// for vertical alignment
fsi-thumbbar .fsi-thumbbar-container .fsi-thumbbar-
thumbnail > img{
vertical-align: top;
}
```

Alternatively, you can still use the alignment parameter.

Alignment of the thumbnails (vertical alignment if horizontal thumb bar and vice versa):

- 1.0: align at bottom (or right)
- 0.5: center images
- 0.0: align at top (left)
- ...or any value inbetween

endlessScrolling	
Description	defines if endless scroll is activated
Syntax	Boolean
Default	false
Context	FSI ThumbBar

Defines if the endless scroll is activated and duplicates images if required.

preloadCount	
Description	The number of images to pre-load.
Syntax	Integer
Default	40
Context	FSI ThumbBar

The number of images to pre-load although they are currently not visible.

Disabling preload (set value to 0) will only load images visible on stage.

autoRotateSpeed	
Description	Auto scroll on start.
Syntax	(Float)

autoRotateSpeed

Default	0
Context	FSI ThumbBar

Auto scroll on start; use positive or negative values to specify the direction. Auto-rotation stops as soon as the user interacts with the bar.

depthFadeout

Description	Darkens images that are further away in z-direction.
Syntax	Boolean
Default	true
Context	FSI ThumbBar

Darkens images that are further away in z-direction (for 3D presentation types).

zoomShaderStartOpacity

Description	The start opacity of the shader when zooming an image.
Syntax	Float
Default	0
Context	FSI ThumbBar

The start opacity (0 to 100) of the shader when zooming an image. See CSS Classes for more options like color.

zoomShaderEndOpacity	
Description	The end opacity of the shader when zooming an image.
Syntax	Float
Default	0
Context	FSI ThumbBar

The end opacity (0 to 100) of the shader when zooming an image. See CSS Classes for more options like color.

autoDestroy	
Description	automatically destroy instances
Syntax	Boolean
Default	true
Context	FSI ThumbBar

Automatically destroy instances created with the fsi-thumbbar tag upon removing the tag from the document DOM.

viewerSelector	
Description	alias for viewerID
Syntax	String
Default	
Context	FSI ThumbBar

Defines a selector (e.g. "#myViewer" or "fsi-viewer" or ".myClass") of an FSI Viewer instance to be used to display the selected image. You may use "auto" to use the first <fsi-viewer> tag in the document (if there is only one).

cmdButtonSelector	
Description	a selector to one or more DOM elements that should be used as control buttons
Syntax	String
Default	
Context	FSI ThumbBar

Defines a selector to one or more DOM elements that should be used as control buttons.

The matched DOM elements need to contain the attribute "data-fsi-cmd" with one of the following values:

firstImage, previousPage, previousImage, nextImage, nextPage, lastPage

See "Adding control buttons" for more information.

PerspectiveAlignment	
Description	Defines the perspective origin for 3D presentation types ("innerRing", "outerRing", "custom").
Syntax	Float
Default	1.0
Context	FSI ThumbBar

Defines the perspective origin for 3D presentation types ("innerRing", "outerRing", "custom").

- 1.0: perspective origin at bottom (or right)
- 0.5: perspective origin at center
- 0.0: perspective origin at top (left)
- ...or any other value

placeholderImage	
Description	Defines the CSS Class and type of the placeholders while images are loading.
Syntax	String
Default	"default"
Context	FSI ThumbBar

Defines the CSS Class and type of the placeholders while images are loading.

- none" (CSS class: "none") - no placeholder at all
- "blank" (CSS class: "blank") - a blank white placeholder
- "default" (CSS class: "default") - the default placeholder with a background image
- "custom" (CSS class: "custom") - a custom placeholder class (add the CSS class as described below)
- [path to an image on FSI Server] (CSS class: "image") - a custom image with a pad effect (see parameter placeholderPadEffect)

To customize the CSS for the placeholder, please use the following CSS rule:

```
div.fsi-thumbbar-root div.fsi-thumbbar-container
img.placeholder.image
```

(replace ".image" with the CSS class listed above).

placeHolderPadEffect	
Description	Defines the pad effect to use when using a custom placeholder image.
Syntax	String
Default	Pad(CC,FFFFFF)
Context	FSI ThumbBar

Defines the pad effect to use when using a custom placeholder image (see parameter [placeHolderImage](#)).

garbageCollectionSize	
Description	Specifies how many images will be kept in memory although they ar not visible anymore.
Syntax	Integer
Default	-1
Context	FSI ThumbBar

Specifies how many images will be kept in memory although they ar not visible anymore.

Use -1 for auto sizing the garbage collection size.

Use 0 to disable garbage collections (all images will be kept in memory, not

recommended for huge collections)

Any other positive number:

At least the specified number of images will be kept in memory.

Can be more images if required by instance size and preloadCount parameter.

6.4 Customization

6.4.1 CSS Classes

The following CSS classes can be used to modify the appearance:

- fsi-thumbbar - The entire thumbbar instance.
- div.fsi-thumbbar-shader - The shader below a zoomed image.
- div.fsi-thumbbar-zoom-div - The div containing the zoomed image.
- div.fsi-thumbbar-container img.placeholder - The place holder shown when a thumbnail loads. See parameter "[placeholderImage](#)" for more details.
- fsi-thumbbar .fsi-thumbbar-container img - enables you to create a border around all thumbnail images, required for the next class - a border around the active thumbnail
- fsi-thumbbar .fsi-thumbbar-container img.fsi-selected-thumb - sets a border around the active thumbnail selection

Example Highlighted Thumbnail:

```
fsi-thumbbar .fsi-thumbbar-container img{
    border:2px solid transparent;
}
fsi-thumbbar .fsi-thumbbar-container img.fsi-
selected-thumb{
    border: 2px solid red;
}
```

6.4.2 Adding Control Buttons

There are two ways to add control buttons:

- using the `registerButton(element, command)` API method
- using the `cmdButtonSelector` parameter and HTML attributes

The following commands are available:

- `firstImage`
- `previousPage`
- `previousImage`
- `nextImage`
- `nextPage`
- `lastPage`

Example:

```
<div id="myThumbBarControls">
<input type="button" data-fsi-cmd="previousImage" value="
previous" />
<input type="button" data-fsi-cmd="nextImage" value="nex
t"/>
</div>

<fsi-thumbbar
cmdButtonSelector="#myThumbBarControls > input"
width="800"
height="400"
dir="images/someFolder"></fsi-thumbbar>
```



Please note:

You can use any HTML element, not just buttons. The CSS class "fsi-pressed" will be added to the DOM element, while the button is pressed.

6.4.3 Defining a custom presentation type

You can create a custom presentation type in addition to the built-in types (see "[presentationType](#)").

To use a custom presentation you need to set "presentationType" to "custom" and define 2 functions.

The function defined by "CustomPresentationInitFunction" will be called on start and on resize.

The function defined by "CustomPresentationFunction" will be called each time the presentation needs to be drawn.

You therefore need to make sure that this function takes very little time to complete, otherwise the presentation will be laggy.

Example:

```
<presentationType value="custom" />
<customPresentationInitFunction value="onThumbBarPresent
ationInit" />
<customPresentationFunction value="onThumbBarPresentatio
nCalc" />
```

Plus the script:

Example:

```

function onThumbBarPresentationInit(oAnimation){
  // oAnimation contains information on the presentation
  // You can add your own properties
  // oAnimation will be passed to your custom calculation
  function
  console.log("init custom FSI ThumbBar presentation");
  console.dir(oAnimation);
  oAnimation.myLeftLimit = -oAnimation.totalWidth /2 - 2 *
  oAnimation.nMaxThumbWidth;
  oAnimation.myRightLimit = oAnimation.totalWidth /2 + 2 *
  oAnimation.nMaxThumbWidth;
  oAnimation.myZDistance = oAnimation.nPerspective /8;
  // nHorizontalFactor is 1 for horizontal thumb bars and
  -1 for vertical thumb bars
  oAnimation.myRotationFactor =
  oAnimation.nHorizontalFactor * 2;
}

function onThumbBarPresentationCalc(oAnimation, oItem){
var ret = 0;
if (oItem.position > oAnimation.myLeftLimit &&
oItem.position < oAnimation.myRightLimit){
  ret = 1;
  // oItem.position is 0 for the centered image, negative
  for images left of the center
  // delta is -1 for images at the left margin, 0 at
  center and 1 at the right margin
  var delta = oItem.position / oAnimation.totalWidth;
  var piDelta = 2 * delta * Math.PI;
  var zRel = Math.cos(piDelta);
  oItem.ry = Math.sin(piDelta)/
  oAnimation.myRotationFactor;
}

```

```

oItem.z = zRel * oAnimation.myZDistance;
oItem.brightness = 1 + (zRel -1) / 6;

// set to true only, if items overlap (items will be z-
// sorted, which is expensive)
// oItem.bSetZIndex = true;
}
// return 1 to indicate that item is on stage, 0 to
// indicate it's not visible
return ret;
}

```

6.5 JavaScript Interface

Initialization:

```

FSIThumbBar = new $FSI.FSIThumbBar ();
FSIThumbBar.init(dir:"images/foo");

```

6.5.1 Public Methods

void	init(elementID, oParameters, bDebug);
	Initializes the FSI ThumbBar instance with the given parameters.

void	printAPI();
	Shows all API methods in the console in alphabetical order.

void	destroy();
	Destroys the FSI ThumbBar instance leaving the empty container <div> only. You can re-use the same container calling FSIThumbBar.init()

boolean	getInitDone();
	Returns if the initialization process is done.

number	getInstanceID();
	Returns the number of the viewer object.

string	getVersion();
	Returns a string containing the FSI ThumbBar software version.

string	getBuild();
	Returns a string containing the FSI ThumbBar software build number.

void	assignFSIViewer(iFSIViewerInstance);
	Assigns a certain FSI Viewer JS instance to FSI ThumbBar for building FSI Showcase JS.

void	focusImage(nImage);
	Scrolls the bar until the image with the given index is in the foreground.

void	zoomImage(nImage);
	Scrolls the bar until the image with the given index is in the foreground and zoom the given image afterwards.

void	closeZoom(evt, bImmediate);
	Remove the zoomed image if any.

bSuccess	addListener(strListenerName, fn, iScope);
	Calls a specific listener.

bSuccess	removeListener(strListenerName, fn);
	Removes a specific listener.

void	dumpListeners();
	Dumps all listeners.

strInstanceName	getInstanceName();
	Returns the name of the viewer object.

void	testAPIListenersStart()
	Starts the API test and shows all called listeners and the parameters which they return.

void	testAPIListenersStop()
	Stops the API test.

bSuccess	buttonDown(strCommand)
	Presses the down button.

bSuccess	buttonUp(strCommand)
	Presses the up button.

bSuccess	changeConfig(strCfgFileName, oParameters)
	<p>Reset the viewer object and change the configuration to the given configuration file.</p> <p>strCfgFileName (optional): path to the configuration file (see "cfg" parameter)</p> <p>oParameters (optional): an object containing parameters. If present, these parameters will overwrite the parameters defined upon initialization.</p>

bSuccess	changeDir(strDirectory)
	<p>Reset the viewer object changes the directory to the given directory.</p>

void	firstImage(nAnimationFrames)
	<p>Selects the first image of the range.</p>

void	addImages(arPathsOrObjects)
	<p>Adds images to FSI ThumbBar.</p>

void	removeImages(arIndice)
	Removes certain images.

void	removeAllImages(bSuccess)
	Removes all images.

mixed	getConfigValue(strName)
	Returns the set config value for the given parameters.

nImages	getImageCount()
	Returns the amount of images used in FSI ThumbBar.

oParameters	getParameters()
	Returns the current parameters used in FSI ThumbBar.

nIndex	getCurrentImageIndex()
	Returns the current image index.

fPosition	getScrollPos()
	Returns the current scroll position.

bScrolling	isScrolling()
	Returns if FSI ThumbBar is currently scrolling.

void	lastImage(nAnimationFrames)
	Selects the last image of the range.

void	nextImage(nAnimationFrames)
	Selects the next image of the range.

void	nextPage(nAnimationFrames)
	Selects the next pages of the range.

void	previousImage(nAnimationFrames)
	Selects the previous image of the range.

void	previousPage(nAnimationFrames)
	Selects the previous page of the range.

bSucces s	registerButton(DOMElement, strCommand)
	Registers a button with the given specifications. (See Adding Control Buttons.)

fPosition	setScrollPos(fPosition, nAnimationFrames)
	Sets the scroll position based on the given specifications

void	startAutoRotate(fSpeed)
	Starts the automatic rotation.

void	stopAutoRotate()
	Stops the automatic rotation.

void	traceConfigValue(strName)
	Traces a config value and enables you to see where (in config files, the _default.xml, etc) a specific value is set.

boolean	unRegisterButton(DOMElement)
	Unregisters a button. (See Adding Control Buttons.)

6.5.2 Callback functions

The optional JavaScript callback functions enables developers to react on events fired by FSI ThumbBar. To use a callback you need to implement a corresponding JavaScript function AND pass the name of the callback function to the FSI ThumbBar instance, e.g.:

Example:

```
function onStart(strDirectory, nImages, arImagePaths){
    console.log("The FSI ThumbBar instance with the id "
    + idElement
    + " displays a total of " + nImages + " images".}
```

```
FSIThumbBar = new $FSI.ThumbBar();
```

```
FSIThumbBar.init(dir:"images/foo",
callBackStart:onStart);
```

**Note:**

You can either pass the function or the function name in window scope as a string.

The following callback functions can be used:

	onStart(strDirectory, nImages, arImagePaths);
	Called once after loading the image list.

	onClick(nIndex, oltem);
	Called each time the user clicks an image.

	onReady();
	Called as soon as the viewer finished loading data and gets interactive.

	onFocus(nImageIndex, strImagePath);
	Called each time the foreground image changes.

	onZoomReady(nImageIndex, strImageURL, eZoomedImage);
	Called as soon as the zoom is ready.

	onZoomStart(nImageIndex, strImageURL);
	Called each time a zoomed image starts loading.

	onZoomEnd();
	Called each time a zoomed image has been closed.

	onDestroy();
	Called as soon as the viewer is destroyed.

	onInit(oParameters);
	Called as soon as the viewer is initialized.

onConfigsReady(oConfigValues);	
	Called as soon as the config is ready.
	onChangeConfig(str CfgFileName, oParameters);
	Called as soon as the config is changed.
onResize(oConfigValues);	
	Called as soon as the instance is resized.
onMetaData(oItem, oMetaData);	
	Called as soon as the meta data is loaded.

	onReplaceTemplateValue(name, value);
	Returns: newValue. Called as soon as the Label Template is replaced.
	onBeforeReplaceLabelTemplates(strLabel, oItem);
	Returns: strNewLabel. Called directly before the Label Template is replaced.

	onAfterReplaceLabelTemplates(strLabel, oltem);
	Returns: strNewLabel. Calles directly after the Label Template is replaced.

	onMouseEnter(nIndex, oltem);
	Called as soon the mouse enters the defined area.

	onMouseLeave(nIndex, oltem);
	Called as soon the mouse leaves the defined area.

	onScrollStart(fPosition);
	Called as soon as the scrolling is started.

	onScrollEnd(fPosition);
	Called as soon as the scrolling is ended.

	onSetScrollRange(fTotalSize, fRange, bEndlessScrolling, nTotalImages);
	Called as soon as the defined scroll range is set.

7 FSI Showcase

FSI Showcase is a combination of the HTML5 and Javascript based viewers FSI Viewer and FSI ThumbBar, for displaying multiple images in a scrollable area with a FSI Viewer instance above.

Supported devices

- iOS 4 or higher
- Android 4.x based devices
- Windows Phone 8 and Windows RT devices
- Windows 8 with touch enabled browsers
- Mouse zoom: desktop or laptop computers & all major browsers



Note on Parameters

As FSI Showcase is build from both FSI Viewer and FSI ThumbBar, the related parameters are not re-listed in this chapter.

You can find the parameters in [Parameters](#) and [Parameters](#).

7.1

Usage

To use FSI Showcase, make sure the respective images on your website come from FSI Server and add the following scripts to the <head> section of your website:

Example:

```

<head>
<script src="applications/viewer/js/fsiviewer.js" type="
text/javascript"></script>
<script src="applications/thumbbar/js/fsithumbbar.js"
type="text/javascript"></script>
</head>

```

FSI Showcase is build of combining the FSI Viewer and FSI ThumbBar tags, assigning the Viewer to ImageFlow with a specific viewer id:

Example:

```

<body>

//Adding FSI Viewer
<fsi-viewer id="viewer1" width="100%" height="600" noNav="
1">
</fsi-viewer>

//Adding FSI ThumbBar, assigning the Viewer with the
viewerID
<fsi-thumbbar viewerID="viewer1" width="100%" height="15
0"
dir="/images/foo/" presentationType="flat">
</fsi-thumbbar>

</body>

```

If you want to add the fullscreen plugin to FSI Showcase, you need to wrap the Viewer and ThumbBar into a container DIV to reserve the proper space for the ThumbBar Element in fullscreen mode, like:

Example:

```
<body>
//Adding Container

<div id="Container_FSI_123" // Used for fullscreen
element parameter of FSI Viewer
  style="position:relative; width:500px; height:500px;
box-sizing:border-box;
padding-bottom:150px;"> // Height of the Imageflow!
//Adding FSI Viewer
  <fsi-viewer id="viewer1" width="100%" height="600"
noNav="1" plugins="fullScreen"
  fullscreenelement="Container_FSI_123">
  </fsi-viewer>
  //Adding FSI ThumbBar , assigning the Viewer with the
viewerID
  <fsi-thumbbar viewerID="viewer1" width="100%" height="
150" dir="/images/foo/"
  presentationType="flat">
  </fsi-thumbbar>

</div>
</body>
```



Note on HTML Codes

The HTML Code generated in the FSI Server interface will change accordingly to the plugins selected.

7.2 Configuration

7.2.1 Defining Image Lists

In order to use FSI Showcase, you can either use old configuration files used for FSI Showcase Flash, or create a new configuration file where all the images are defined. The basics of a general configuration can be found in the chapter [Using XML Configuration files](#).

This is an example of how a Showcase XML Configuration file could look like:

Example:

```

<?xml version="1.0" encoding="UTF-8"?>
<fsi_parameter>
  <Viewer>
    <skin value="white" />
    <noNav value="true" />
  </Viewer>

  <ThumbBar>
    <paddingTop value="15" />
  </ThumbBar>

  <Options>
    <imageListParameterFilterPositive value="initial
View, thumbLabel" />
    <Language value="english"/>
  </Options>

  <!-- Showcase Images to display below -->
  <Images>
    <Image>
      <images3d prefix="/Storage/Spin/image-"
suffix=".png" from="01" to="20" />
      <Options>
        <thumbLabel value="360 View" />
      </Options>
    </Image>

    <Image label="Premium Touchpad">
      <images3d prefix="/Storage/Spin/image-"
suffix=".png" from="01" to="20" />
      <Options>

```

```

        <InitialView value="1,1,0.419097,0.60924
5,0.580208,0.776693,0" />
        <thumbLabel value="Premium Touchpad" />
    </Options>
</Image>

    <Image label="USB, Mini VGA and Slim Kensington
case-lock ">
        <images3d prefix="/Storage/Spin/image-"
suffix=".png" from="01" to="20" />
        <Options>
            <thumbLabel value="USB, Mini VGA and
Slim Kensington case-lock" />
            <InitialView value="1,7,0.488666,0.62542
3,0.703314,0.848514,0" />
        </Options>
    </Image>

</Images>

</fsi_parameter>

```

When defining the image list, you can still use the old configuration way:

Example:

```

<images3d prefix="/images/foo_" suffix=".jpg">
    <image src="01" />
    <image src="02" />
    [...]
    <image src="20" />
</images3d>

```

In order to simplify the configuration, we have now added the possibility to define a range of images rather than listing all images:

Example:

```
<images3d prefix="/images/samples/foo_" suffix=".jpg"
from="01" to="20" />
```

Both definitions create a list of: `<image src="/images/samples/foo_01.jpg" />` to `<image src="/images/samples/foo_20.jpg" />`.

7.2.2 Filtering Image Lists

As seen in the example XML above, you can filter the image lists for certain parameters.

imageListParameterFilterPositive	
Description	positive image list parameter filter
Syntax	String
Default	
Context	Configuration

Define, which parameters in a sub configuration of an image list will pass the filter.

You can define multiple parameter names separated by commas.

E.g. "fpSrc, thumbLabel" will ignore all parameters except "fpSrc" and "thumbLabel".

imageListParameterFilterNegative

Description	negative image list parameter filter
Syntax	String
Default	
Context	Configuration

Define, which parameters in a sub configuration of an image list will not pass the filter.

You can define multiple parameter names seperated by commata.

E.g. "fpXSrc, thumbLabel" will accept all parameters except "fpXSrc" and "thumbLabel".

7.2.3 Using Labels in FSI ThumbBar

Defining labels

You have two options to define labels:

1) adding the label to an <image> tag as attribute. This is the way old configuration (Flash) files used to add the label:

Example:

```

<images>
  <image label="foo">
    [...]
  </image>
  <image label="bar">
    [...]
  </image>
</images>

```

2) adding a "thumbLabel" Parameter to your configuration. You can define this as a general parameter in the main configuration or in a sub configuration of the image list.

Example Main Configuration:

```

<options>
  <thumbLabel value="###thumb.fileName###" />
  [...]
</options>

```

This makes sense if you either want to have the same label for every thumbnail or if you want to create them dynamically (see below).

Example Sub Configuration:

```

<images>
  <image>
    <options>
      <thumbLabel value="Thumbnail Name" />
      [...]
    </options>
  </image>
</images>

```

Label Values

The label value will be url-decoded. Therefore e.g. "%20" will be transformed into space.

If you want to use image information inside the label, you can use space holders:

####thumb.fileName#### - the file name of the image

####thumb.filePath#### - the file path of the image

####thumb.index#### - the numeric index of the image [0,1,2,3...]

In addition, you can use any information from an images "info" request. The available meta data depends on the image and the image info template (parameter "imageInfoTemplate").

By default the value of "imageInfoTemplate" is "info.json" and reveals the following information:

####width#### - width of the source image in pixel

####height#### - height of the source image in pixel

####size#### - file size of the source image in byte

####src#### - file path of the image

####alpha#### - image contains an alpha channel ("true") or not ("false")

You can create more custom info templates, that reveal more data, like IPTC or EXIF data. The template in the label must match the name of the meta data

exactly.

If the result of the info template (JSON) contains objects, please use the dot notation like in Javascript:

```
###general.icc###  
###iptc.Date Created###  
###exif.Exposure time###
```

Using own template values or modifying template values

You can use the "onReplaceLabelTemplate" callback to modify the template value or to set the value of a custom template name of your own.

Example 1: custom template values:

```
var onReplaceLabelTemplate = function(strTemplateName,  
  strValue, oItem, oInfo){  
  // this replaces "###custom.foo###" in the label  
  with "bar"  
  if (strTemplateName === "custom.foo") return "bar";  
}
```

Example 2: modify template values:

```
var onReplaceLabelTemplate = function(strTemplateName,
strValue, oItem, oInfo){
    if (strValue === undefined) return;

    // this adds " px" to "###width###" and
    "###height###" in the label
    if (strTemplateName === "width" || strTemplateName
=== "height")
        return strValue + " px";
}

onReplaceLabelTemplate:{a:"strTemplateName, strValue,
oItem, oInfo", r:"strNewValue"}
```

8 FSI Image Grid

FSI Image Grid is a simple HTML5 and Javascript based viewer which enables you to display an image gallery as a grid, optionally with captions and descriptions generated from image metadata.

8.1 Usage

I) Add the `fsiimagegrid` script to the head of your document:

Example:

```
<head>  
<script src="/viewer/applications/imagegrid/js/  
fsiimagegrid.js"></script>  
</head>
```

II) Add a `<fsi-imagegrid>` tag to the part of your document body where FSI Image Grid should be displayed. Add the desired dimension to it and image source (directory) to it:

Example:

```
<body>
<fsi-imagegrid
dir="images/"
cellWidth="300"
cellHeight="250"
>
</fsi-imagegrid>
</body>
```

Parameters are added to the `<fsi-imagegrid>` tag.

8.2 Parameters

Parameters are added to the `<fsi-imagegrid>` tag.

Example:

```
<body>
<fsi-imagegrid
  dir="images/"
  cellWidth="300"
  cellHeight="250"
  useTouchZoom="true"
  useQuickZoom="false"
  autoCrop="cc"
>
</fsi-imagegrid>
</body>
```

debug	
Description	displays debug & status information in the javascript console.
Syntax	Boolean
Default	false
Context	FSI Image Grid

Display debug and status information in the browser's JavaScript console.

format	
Description	defines the format used for the viewer.
Syntax	Boolean
Default	false
Context	FSI Image Grid

Defines the format used for the viewer.

Default is auto which automatically chooses the best format depending on the browser; alternatively you can choose WEBP, JPEG, PNG or GIF.

Auto delivers the images adaptively as WEBP in supporting browsers, and switches to PNG or JPEG on unsupported browsers.

If you set WEBP as a format, please keep in mind that certain browsers (currently Safari and Internet Explorer) do not support the format and will not show the image.

If you would like to use WEBP, the best way would be to set auto as the format.

dir	
Description	path for the images used for the grid
Syntax	String
Default	
Context	FSI Image Grid

Defines the directory path which contains the images used for the grid.

width	
Description	defines the width of the grid.
Syntax	integer
Default	-
Context	FSI Image Grid

Defines the width of the FSI Image Grid instance in % or px.

height	
Description	defines the height of the grid.
Syntax	integer
Default	-
Context	FSI Image Grid

Defines the height of the FSI Image Grid instance in % or px.

cellWidth	
Description	defines the width of each image cell in px.
Syntax	integer
Default	-
Context	FSI Image Grid

Defines the width of each image cell in px.

cellHeight	
Description	defines the height of each image cell in px.
Syntax	integer
Default	-
Context	FSI Image Grid

Defines the height of each image cell in px.

garbageCollectionSize	
Description	specifies how many images will be kept in memory
Syntax	integer
Default	-1
Context	FSI Image Grid

Specifies how many images will be kept in memory although they are not visible anymore.

metaDataTemplate	
Description	specifies server side template for meta data
Syntax	string
Default	details.json
Context	FSI Image Grid

Defines the server side template file to load meta data with.

preloadCount	
Description	specifies the number of images to pre-load
Syntax	integer
Default	-
Context	FSI Image Grid

The number of images to pre-load although they are currently not visible. Disabling preload (set value to 0) will only load images visible on stage.

cfg	
Description	relative path to an XML configuration file in FSI Image Grid format
Syntax	String

cfg	
Default	""
Context	FSI Image Grid

The relative path to an XML configuration file in FSI Image Grid format.

autoCrop	
Description	Crop images to fill entire image area
Syntax	String
Default	"false"
Context	FSI Image Grid

Crop images to fill entire image area. Default is false. Use any combination of t,c,b and l,c,r where tl is top-left.

useQuickZoom	
Description	uses FSI QuickZoom for the grid images
Syntax	String
Default	"false"
Context	FSI Image Grid

Defines if FSI QuickZoom is used for the grid images. If activated, the images will be magnified if you hover over them.

useTouchZoom	
Description	uses FSI TouchZoom for the grid images (touchscreen only)
Syntax	String
Default	"false"
Context	FSI Image Grid

Defines if FSI TouchZoom is used for the grid images. If activated, the images will be magnified if you pinch-zoom into the website with a touchscreen device.

viewerSelector	
Description	alias for viewerID
Syntax	String
Default	
Context	FSI Image Grid

Defines a selector (e.g. "#myViewer" or "fsi-viewer" or ".myClass") of an FSI Viewer instance to be used to display the selected image. You may use "auto" to use the first <fsi-viewer> tag in the document (if there is only one).

imageListLimit	
Description	limits the image list to a certain amount of images
Syntax	String

imageListLimit

Default	""
Context	FSI Image Grid

Limits the image list to a certain amount of images within the directory. The parameter is used like this: "0,10" - the first value defines the starting image, the second the amount of images displayed. In this case it would start at the first image and show the first ten images. "5,5" would start the list with the fifth image and shows the fifth image plus the four images that are listed behind it.

imageListSort

Description	sorts the image list
Syntax	String
Default	"filename"
Context	FSI Image Grid

Sorts the image list with any valid sort item name for FSI Server. Available sort names:

- "filename" (default)
- "width"
- "height"
- "lastmodified"
- "resolution"
- "importstatus"

imageListSortOrder	
Description	defines the order of the image list sorting
Syntax	String
Default	"asc"
Context	FSI Image Grid

Defines the order of the image list sorting. Possible values: "asc" (Ascending) or "desc" (Descending).

ListFilterPositive	
Description	filters the image list using RegEx, includes matching images
Syntax	String
Default	-
Context	FSI Image Grid

Filters the image list to a certain amount of images within the directory using RegEx. If images match the Regular Expression, they will be included in the image list. If both ListFilterPositive and ListFilterNegative are used, ListFilterPositive is always used first. The filter will be applied before any other parameter is applied, i.e. all other parameters only apply to the already filtered list.

Example: ListFilterPositive="/\09\d*.tif/i"

ListFilterNegative	
Description	filters the image list using RegEx, excludes matching images
Syntax	String
Default	-
Context	FSI Image Grid

Filters the image list to a certain amount of images within the directory using RegEx. If images match the Regular Expression, they will be excluded from the image list. If both ListFilterPositive and ListFilterNegative are used, ListFilterPositive is always used first. The filter will be applied before any other parameter is applied, i.e. all other parameters only apply to the already filtered list.

Example: ListFilterNegative="/\09\d*.tif/i"

8.3 JavaScript Interface

Initialization:

```
FSIImageGrid = new $FSI.FSIImageGrid ();
FSIImageGrid.init(dir:"images/foo");
```

8.3.1 Public Methods

bSuccess	addListener(strListenerName, fn, iScope)
	Calls a specific listener.

bSuccess	removeListener(strListenerName, fn);
	Removes a specific listener.

void	dumpListeners();
	Dumps all listeners.

void	assignFSIViewer(iFSIViewerInstance);
	Assigns a certain FSI Viewer JS instance to FSI ImageGrid.

void	destroy();
	Destroys the FSI Image Grid instance leaving the empty container <div> only.

bDone	getInitDone();
	Returns if the initialization process is done.

nInstanceID	getInstanceID();
	Returns the number of the viewer object.

strVersion	getVersion();
	Returns a string containing the FSI Image Grid software version.

strBuild	getBuild();
	Returns a string containing the FSI Image Grid software build number.

mixed	getConfigValue(strName)
	Returns the set config value for the given parameters.

strInstanceName	getInstanceName();
	Returns the name of the viewer object.

oParameters	getParameters();
	Returns the parameters of the viewer object.

bSuccess	changeDir(strDirectory);
	Changes directory used for the grid.

void	downloadImage(nSpriteIndex, nMaxDimension, strRenderer, oQueryParameters);
	Downloads image.
void	downloadSourceImage(nSpriteIndex);
	Downloads source image.
nImages	getImageCount();
	Returns the amount of images.

url	getImageDownloadURL(nSpriteIndex, nMaxDimension, strRenderer, oQueryParameters);
	Returns the image download URL.

url	getSourceImageDownloadURL(nSpriteIndex);
	Returns the source image download URL.

nPos	getScrollPos();
	Returns the current scroll position.

void	setScrollPos(newPos);
	Sets a new scroll position.

bSuccess	scrollToRow(nRow, fn);
	Scrolls to a certain row.

bSuccess	scrollToThumbIndex(nIndex, fn);
	Scrolls to a specific thumb index.

oRange	getVisibleRange();
	Returns the currently visible image range.

void	printAPI();
	Shows all API methods in the console in alphabetical order.

void	traceConfigValue(strName);
	Traces a config value and enables you to see where (in config files, the _default.xml, etc) a specific value is set.

void	testAPIListenersStart();
	Starts the API test and shows all called listeners and the parameters which they return.
void	testAPIListenersStop();
	Stops the API test.

8.3.2 Callback functions

The optional JavaScript callback functions enables developers to react on events fired by FSI Image Grid.

The following callback functions can be used:

	onDestroy();
	Called as soon as the viewer is destroyed.

	onInit(oParameters);
	Called as soon as the viewer is initialized.

	onCellMouseDown(event, oCell);
	Called as soon as a mouse button is pressed.
	onCellMouseUp(event, oCell);
	Called as soon as a mouse button is released.
	onCellMouseOver(event, oCell);
	Called as soon as the cursor is hovered over a cell.
	onCellMouseOut(event, oCell);
	Called as soon as the hovering cursor is leaving a cell.

	onCellClick(event, oCell);
	Called as soon as a cell is clicked.
	onConfigsReady(oConfigValues);
	Called as soon as the configuration is loaded.
	onGetInlineTemplate(nodeTemplate);
	Called as soon as the inline template is loaded.
	onLanguageData(oLanguageItems);
	Called as soon as the language data is loaded.
	onReady();
	Called as soon as the instance is ready.
	onLayoutChanged();
	Called as soon as the layout is changed.
	onMetaData();
	Called as soon as the meta data is loaded.
newValue	onReplaceTemplateValue(name, value);
	Called as soon as the template value is replaced.
	onAfterReplaceTemplateValue(strContent, oCell);
	Called after the template value is replaced.

	onReset();
	Called as soon as the instance is reset.

	onScroll();
	Called as soon as a scroll action takes place.
	onVisibleRangeChanged(nStart, nEnd);
	Called as soon as the visible image range changes.

9 FSI Image Twins Game

FSI Image Twins is a simple HTML5 and Javascript based game in which the user has to find pairs of identical images.

9.1 Usage

I) Add the `fsiimagetwins` script to the head of your document:

Example:

```
<head>  
<script src="/viewer/applications/imagetwins/js/  
fsiimagetwins.js"></script>  
</head>
```

II) Add a `<fsi-image-twins-game>` tag to the part of your document body where FSI Image Twins should be displayed. Add the desired dimension to it and image source (directory) to it:

Example:

```
<body>
<fsi-image-twins-game
dir="images/"
  width="100%"
  height="100%"
  columns="6"
  rows="6"
>
</fsi-image-twins-game>
</body>
```

Parameters are added to the `<fsi-image-twins-game>` tag.

9.2 Parameters

Parameters are added to the `<fsi-image-twins-game>` tag.

Example:

```

<body>
<fsi-image-twins-game
dir="images/"
  width="100%"
  height="100%"
  spacing="20"
  naturalrotation="60"
  columns="6"
  rows="6"
>
</fsi-image-twins-game>
</body>

```

debug

Description	displays debug & status information in the javascript console.
Syntax	Boolean
Default	false
Context	FSI Image Twins

Display debug and status information in the browser's JavaScript console.

format

Description	defines the format used for the viewer.
-------------	---

format	
Syntax	Boolean
Default	false
Context	FSI Image Twins

Defines the format used for the viewer.

Default is auto which automatically chooses the best format depending on the browser; alternatively you can choose WEBP, JPEG, PNG or GIF.

Auto delivers the images adaptively as WEBP in supporting browsers, and switches to PNG or JPEG on unsupported browsers.

If you set WEBP as a format, please keep in mind that certain browsers (currently Safari and Internet Explorer) do not support the format and will not show the image.

If you would like to use WEBP, the best way would be to set auto as the format.

dir	
Description	path for the images used for the game
Syntax	String
Default	
Context	FSI Image Twins

Defines the directory path which contains the images used for the game.

language	
Description	user interface language

language	
Syntax	String
Default	
Context	FSI Image Twins

Defines the language of the user interface.

timeCardsVisible	
Description	time in ms before cards are covered again
Syntax	Integer
Default	700
Context	FSI Image Twins

Delay in ms before uncovered cards will be covered again.

cardBackImage	
Description	Path to an image to display as the back of the cards
Syntax	String
Default	none
Context	FSI Image Twins

Path to an image to display as the back of the cards or 'none' for no image.

cardBackImageCropAlign

Description	Defines which part of the background image will be used
Syntax	String
Default	cc
Context	FSI Image Twins

Defines which part of the background image will be used. The first character specifies the horizontal alignment: l = left | c = center | r = right | v = random. The second character specifies the vertical alignment: t = top | c = center | b = bottom | v = random.

cardBackImageEffects

Description	server side image effects to apply to the card background image
Syntax	String
Default	-
Context	FSI Image Twins

Defines server side image effects to apply to the card background image.

cropAlign

Description	part of the images which will be used for the cards
Syntax	String
Default	cc
Context	FSI Image Twins

Defines which part of the images will be used for the cards. The first character specifies the horizontal alignment: l = left | c = center | r = right | v = random. The second character specifies the vertical alignment: t = top | c = center | b = bottom | v = random.

effects	
Description	image effects used for the card images
Syntax	String
Default	-
Context	FSI Image Twins

Defines server side image effects to apply to the image(s).

columns	
Description	Number of images in a row.
Syntax	Integer
Default	1
Context	FSI Image Twins

Number of images in a row.

rows	
Description	Number of images in a column.
Syntax	Integer

rows	
Default	1
Context	FSI Image Twins

Number of images in a column.

imagemargin	
Description	Spacing between the image and the edges of the card in px
Syntax	Integer
Default	6
Context	FSI Image Twins

Spacing between the image and the edges of the card in px.

naturalrotation	
Description	Random rotation of the images/cards in degree
Syntax	float
Default	3
Context	FSI Image Twins

Random rotation of the images/cards in degree.

spacing	
Description	Spacing between the cards in px.
Syntax	Integer
Default	8
Context	FSI Image Twins

Spacing between the cards in px.

9.3 JavaScript Interface

Initialization:

```
FSIImageTwins = new $FSI.FSIImageTwins ();
FSIImageTwins.init(dir:"images/foo");
```

9.3.1 Public Methods

void	init(elementID, oParameters, bDebug);
	Initializes the FSI Image Twins instance with the given parameters.

bSuccess	addListener(strListenerName, fn, iScope)
	Calls a specific listener.

bSuccess	removeListener(strListenerName, fn);
	Removes a specific listener.

void	destroy();
	Destroys the FSI Image Twins instance leaving the empty container <div> only.

boolean	getInitDone();
	Returns if the initialization process is done.

number	getInstanceID();
	Returns the number of the viewer object.

strVersion	getVersion();
	Returns a string containing the FSI Image Twins software version.

strBuild	getBuild();
	Returns a string containing the FSI Image Twins software build number.

mixed	getConfigValue(strName)
	Returns the set config value for the given parameters.

strInstanceName	getInstanceName();
	Returns the name of the viewer object.

oParameters	getParameters();
	Returns the parameters of the viewer object.

oStatistics	getStatistics();
	Returns the statistics of the game.

void	printAPI();
	Shows all API methods in the console in alphabetical order.

void	restartGame();
	Restarts the game.

void	start();
	Starts the game.

void	traceConfigValue(srtName);
	Traces a config value and enables you to see where (in config files, the _default.xml, etc) a specific value is set.

void	uncoverCards();
	Uncovers all cards.

9.3.2 Callback functions

The optional JavaScript callback functions enables developers to react on events fired by FSI Image Twins. To use a callback you need to implement a corresponding JavaScript function AND pass the name of the callback function to the FSI Image Twins instance, e.g.:

Example:

```
function onStart(strDirectory, nImages, arImagePaths){
    console.log("The FSI Image Twins instance with the
id " + idElement
    + " displays a total of " + nImages + " images".}
```

```
FSIImageTwins = new $FSI.ImageTwins();
```

```
FSIImageTwins.init(dir:"images/foo",
callBackStart:onStart);
```

**Note:**

You can either pass the function or the function name in window scope as a string.

The following callback functions can be used:

	onGameStart(nTotalCards);
	Called once after all cards have appeared.

	onGameEnd(oGameStats);
	Called once after the game is finished.

	onCardUncovered();
	Called when one card is uncovered.

	onCardsUncovered();
	Called when all cards are uncovered.

	onCardsCovered();
	Called when all cards are covered.

	onDestroy();
	Called as soon as the viewer is destroyed.

	onInit();
	Called as soon as the viewer is initialized.

	onPairFound(oGameStats, bByChance);
	Called each time a matching pair is found.

	onSkinChanged(strCurrentSkin, strSkinBefore);
	Called when the skin is changed.

10 Appendix

10.1 Escaping or URL-encoding parameter values

In some situations you need to pass escaped (URL-encoded) parameters values to FSI Viewer, because using unescaped values would break the XML syntax or because you need to use characters prohibited in URLs.

In cases like this you can pass escaped values rather than passing the actual value.

What does escaping (URL-encoding) mean?

URL-encoding (or percent-encoding) means converting the character to its corresponding value in ASCII and then representing that value as a pair of hexadecimal digits. The digits, preceded by a percent sign ("%"), are then used in place of the reserved character. FSI Viewer transforms URL-encoded values back to the original value.

How can I URL-encode a value?

Most scripting languages (JavaScript, ActionScript, PHP and alike) provide methods for this purpose. Please note that FSI Viewer requires Unicode safe encoding rather than non-unicode safe encoding – this is an escaped character might be represented by one or more 2-digit numbers preceded by "%".

Using JavaScript you therefore need to use the method "encodeURIComponent()" instead of "escape()".

10.2 HTML Tags available in FSI Viewer

FSI Viewer supports basic HTML tags in various contexts like when entering custom tool tips, texts for the "LargeToolTips" plug-in, search results and alike. Whenever this documentation refers to "Basic HTML formatting tags", the following HTML tags can be used (variable values printed bold italic):

HTML Tags

```
<b></b>  
<i></i>  
<u></u>  
<br/>  
<font color="#FF0000" size="12" face="Arial"></font>  
<p align="left|center|right"></p>
```

Please note that you need to use XML syntax in order to avoid XML syntax errors in configuration files - this is e.g. using `
` instead of `
`.

10.3 Example of a custom skin CSS file

In order to use a custom skin, the easiest way would be to duplicate one of the default skin CSS files and adapt them to your liking. Make sure to use a custom class in front of ALL classes defined in the custom CSS, otherwise you will break other skins on the same HTML document.

General appearance CSS rules, which are valid on an overall level, (e.g. the logo container, height of the menubar, etc.) are defined in the corresponding core CSS files, which can be found in `/fsi/web/viewer/skins/resources`. (`fsi-core.css`, `fsi-viewer-core.css`, `fsi-pages-core.css`)



IMPORTANT:

Never change the classes of the core CSS in the core files directly. If you would like to adapt those CSS rules, please overwrite them in a custom skin file or in the HTML document instead.

Example:

```

/* IMPORTANT NOTES */
/* - make sure to use a custom class in front of ALL
classes defined here
(in this sample: .fsi-skin-example) */
/* otherwise you will break other skins on the same HTML
document */
/* enables a floating menu bar which overlaps with the
image */
/* useful for transparent menu bars */
/* baseSize defines the size of all skin elements
(default 16) */
/* baseEnlargement defines the general enlargement
of the icons when the viewport is changed, default is 8
*/

.fsi-skin-example .fsi-ui-info {
  content: '{"floatingMenuBar":true,
"floatingNavWindow":false, "baseEnlargement":10}';
}
/* the main menu bar container */
.fsi-skin-example .fsi-ui-menu-bar {
  background: rgba(255, 255, 255, 0.8);
}
/* The logo displayed in the menu bar.
Custom logos need to be placed into the /fsi/web/viewer/
skins/resources/ folder of
your FSI Viewer installation.
NOTE: Originally, this is defined in the fsi-viewer-
core.css.
Since the core css files should not be altered, please
overwrite the classes from
there in your custom skin CSS. */
.fsi-viewer-root .fsi-skin-example .fsi-ui-logo-image {

```

```

background-image:url("[fsi-skin-path]resources/
custom_logo.svg");
width: 3.2em;
height: auto;
margin-left:0.15em;
}
/* defines the position of the loading animation */
.fsi-skin-example .fsi-viewer-loading-animation {
left:50%;
top:50%;
transform:translate(-50%, -50%);
}
/* the base button class */
.fsi-skin-example .fsi-ui-button {
background: rgba(255,255,255,0.2);
border:1px solid solid rgba(255,255,255,0.2);
border-radius: 6px;
}
/* styles for hovered buttons */
.fsi-skin-example .fsi-ui-button-hover {
background-color:#FFF;
box-shadow: 2px 2px 2px rgba(0,0,0,0.3);
border:1px solid rgba(56,176,170,0.2);
}
/* styles for pressed buttons */
.fsi-skin-example .fsi-ui-button-active {
border:1px solid rgba(56,176,170,0.2);
background:#ffffff;
box-shadow: inset 2px 2px 5px rgba(0,0,0,0.3);
}
/* the base button icon class */
.fsi-skin-example .fsi-ui-button-icon {
color: #33b1aa;
}
.fsi-skin-example .fsi-ui-button-disabled .fsi-ui-
button-icon {
color:#bec7c6;
}

```

```

}
.fsi-skin-example .fsi-ui-button-hover .fsi-ui-button-ic
on {
}
.fsi-skin-example .fsi-ui-button-active .fsi-ui-button-i
con {
}
.fsi-skin-example .fsi-ui-menu-bar-disabled .fsi-ui-
button-icon {
  color: #bec7c6;
}
/* select frame */
/* PSEUDO CLASS, only these 2 values will be read */
.fsi-skin-example .fsi-ui-select-frame {
  border-color:#33b1aa;
  background-color: rgba(255, 255, 255, 0.25);
}
/* progress bar displayed when loading image sequences
*/
/* PSEUDO CLASS, only these 3 values will be read */
.fsi-skin-example .fsi-ui-progressbar {
  color:#33b1aa;
  background-color:rgba(255,255,255,0.5);
  border-color:#999;
}
/* PSEUDO CLASS, only the color values will be read */
.fsi-skin-example .fsi-ui-progressbar-text {
  color:#555;
}
/* tool tips */
.fsi-skin-example .fsi-ui-tool-tip {
  color:#4d4d4d;
  background-color:rgba(255,255,255,0.8);
  border:1px solid #4d4d4d;
  box-shadow: 2px 2px 2px rgba(0,0,0,0.5);
}
.fsi-skin-example .fsi-ui-tool-tip-arrow {

```

```
border-top: 7px solid #4d4d4d;
}
/* navigation window */
.fsi-skin-example .fsi-ui-nav-window {
  background-color: rgba(255,255,255,0.8);
}
.fsi-skin-example .fsi-ui-nav-window-image {
  border: 1px solid #33b1aa;
  background-color: rgba(255,255,255,0.8);
}
/* PSEUDO CLASS, only these 2 values will be read */
.fsi-skin-example .fsi-ui-nav-frame {
  border-color: #33b1aa;
  background-color: rgba(255,255,255,0.35);
}
/* the text 0.0% to 100.0% below the nav window image */
.fsi-skin-example .fsi-ui-nav-window-zoom-text {
  color:#4d4d4d;
}
/* HotSpots */
.fsi-skin-example .fsi-ui-hotspot {
  color:#fff;
  border:1px solid rgba(255,255,255, 1.0);
  border-radius: 2px;
  background-color: rgba(88, 168, 255, 0.85);
  box-shadow: 2px 2px 2px rgba(0,0,0,0.3);
}
.fsi-skin-example .fsi-ui-hotspot-hover {
  background-color: rgba(88, 168, 255, 1.0);
}
.fsi-skin-example .fsi-ui-hotspot-active {
background-color: rgba(88, 168, 255, 1.0);
}
.fsi-skin-example .fsi-ui-hotspot-line-color {
  color: #336699;
}
}
```

```
.fsi-skin-example .fsi-ui-hotspot-line-background-color
{
  color: #113399;
}
/* dialogs */
.fsi-skin-example .fsi-dialog{
  border:0px none;
  background-color:#FFF;
  color:#206662;
}
.fsi-skin-example .fsi-dialog input[type="button"] {
  font-size: 14px;
  color: #666;
  border:1px solid #eee;
  background-color: transparent;
}
.fsi-skin-example .fsi-dialog input[type="button"]:hover
{
  color: #206662;
  background-color: #EEE;
}
/* FSI Pages */
.fsi-skin-example .fsi-ui-button.PageInput {
  background-color: white;
  border:1px solid #CCC;
  color: #333;
}
.fsi-skin-example .fsi-ui-button.PageInput input:focus {
  border-color:#999;
  color: #000;
}
}
```

II Index

A

Appendix

- Encoding Parameter Values [402](#)
- HTML-Tags [402](#)
- Skin Example [403](#)

F

FSI Image Grid

- Callbacks
 - onAfterReplaceTemplateValue [384](#)
 - onCellClick [384](#)
 - onCellMouseDown [383](#)
 - onCellMouseOut [383](#)
 - onCellMouseOver [383](#)
 - onCellMouseUp [383](#)
 - onConfigsReady [384](#)
 - onDestroy [383](#)
 - onGetInlineTemplate [384](#)
 - onInit [383](#)
 - onLanguageData [384](#)
 - onLayoutChanged [384](#)
 - onMetaData [384](#)
 - onReady [384](#)
 - onReplaceTemplateValue [384](#)
 - onReset [385](#)
 - onScroll [385](#)
 - onVisibleRangeChanged [385](#)
- Parameters
 - autoCrop [374](#)
 - cellHeight [372](#)
 - cellWidth [372](#)
 - cfg [373](#)
 - debug [370, 370](#)
 - dir [371](#)
 - garbageCollectionSize [372](#)
 - height [371](#)
 - imageListLimit [375](#)

- [imageListSort](#) 376
- [imageListSortOrder](#) 377
- [ListFilterNegative](#) 378
- [ListFilterPositive](#) 377
- [metaDataTemplate](#) 373
- [preloadCount](#) 373
- [useQuickZoom](#) 374
- [useTouchZoom](#) 375
- [viewerSelector](#) 375
- [width](#) 371
- Public Methods
 - [addListener](#) 379
 - [assignFSIViewer](#) 379
 - [changeDir](#) 380
 - [destroy](#) 379
 - [downloadImage](#) 381
 - [downloadSourceImage](#) 381
 - [dumpListeners](#) 379
 - [getBuild](#) 380
 - [getConfigValue](#) 380
 - [getImageCount](#) 381
 - [getImageDownloadURL](#) 381
 - [getInitDone](#) 379
 - [getInstancelD](#) 379
 - [getInstanceName](#) 380
 - [getParameters](#) 380
 - [getScrollPos](#) 381
 - [getSourceImageDownloadURL](#) 381
 - [getVersion](#) 380
 - [getVisibleRange](#) 382
 - [printAPI](#) 382
 - [removeListener](#) 379
 - [setScrollPos](#) 381, 382, 382
 - [testAPIListenersStart](#) 382
 - [testAPIListenersStop](#) 382
 - [traceConfigValue](#) 382
- Usage 368

FSI Image Twins

- Callbacks
 - onCardsCovered [400](#)
 - onCardsUncovered [400](#)
 - onCardUncovered [400](#)
 - onDestroy [400](#)
 - onGameEnd [399](#)
 - onGameStart [399](#)
 - onInit [400](#)
 - onPairFound [401](#)
 - onSkinChanged [401](#)
- Parameters
 - cardBackImage [390](#)
 - cardBackImageCropAlign [391](#)
 - cardBackImageEffects [391](#)
 - columns [392](#)
 - cropAlign [391](#)
 - debug [388](#), [388](#)
 - dir [389](#)
 - effects [392](#)
 - imagemargin [393](#)
 - language [389](#)
 - naturalrotation [393](#)
 - rows [392](#)
 - spacing [394](#)
 - timeCardsVisible [390](#)
- Public Methods
 - addListener [395](#)
 - destroy [395](#)
 - getBuild [396](#)
 - getConfigValue [396](#)
 - getInitDone [395](#)
 - getInstanceName [396](#), [397](#)
 - getParameters [397](#)
 - getVersion [396](#)
 - init [394](#)
 - printAPI [397](#)
 - removeListener [395](#)
 - restartGame [397](#)
 - start [397](#)
 - traceConfigValue [398](#)
 - uncoverCards [398](#)
- Usage [386](#)

FSI ImageFlowThumbBar

- Callbacks
 - onClick [352](#)
 - onReady [353](#)
 - onStart [352](#)
- Parameters
 - autoDestroy [335](#)

FSI Pages

- Usage
 - Special URL values [224](#)

FSI Pages JS

- How it works [212](#)
- Public Methods
 - dumpListeners [296](#)
 - traceConfigValue [286](#)
- Usage [213](#)
 - Aspect Ratio [220](#)
 - Defining Image Collections [217](#)
 - Presets [220](#)

Index

FSI Pages JS JavaScript Interface

- Callbacks
 - onAfterRegisterExternalButton [300](#)
 - onAutoPageLayoutChange [302](#)
 - onBookmarkAdded [302](#)
 - onBookmarkRemoved [303](#)
 - onBookmarksLoaded [303](#)
 - onBookmarksSaved [303](#)
 - onChangeConfig [298](#)
 - onClickDemoMode [306](#)
 - on onDestroy [297](#)
 - onEnterDemoMode [307](#)
 - onExitDemoMode [307](#)
 - onFullScreen [300](#)
 - onGetChaptersData [307](#)
 - onGetIntroContent [308](#)
 - onInitFailed [297](#)
 - onLinkHover [308](#)
 - onMenuButtonClicked [299](#)
 - onMenuButtonEnabled [298](#)
 - onMenuButtonPressed [298](#)
 - onMenuButtonReleased [299](#)
 - onMenuButtonSetPressed [299](#)
 - onMenuDestroy [298](#)
 - onMenuEnabled [298](#)
 - onMenuReady [300](#)
 - onOpenPageLink [305](#)
 - onPageChanged [300](#)
 - onPageLayoutChanged [302](#)
 - onPageSizeChanged [304](#)
 - onPageToolTip [305](#)
 - onPageZoomed [304, 304](#)
 - onPrintPages [304](#)
 - onReady [297](#)
 - onRegisterExternalMenuButtons [299](#)
 - onRemoveAllBookmarks [303](#)
 - onResize [305](#)
 - onSearchInit [306](#)
 - onSearchResults [306](#)
 - onSearchStart [306](#)
 - onShowBookmarkList [301](#)
 - onShowChapters [301](#)
 - onShowChaptersData [301](#)
 - onShowPrintDialog [302](#)
 - onShowSearchDialog [301, 307, 307](#)
 - onSkinChanged [305](#)
- Public Methods
 - addListener [287](#)

- [changeConfig](#) 284
- [clickMenuButton](#) 289
- [debugEnabled](#) 285
- [debugError](#) 285
- [debugLog](#) 286
- [debugWarn](#) 286
- [destroy](#) 285
- [firstPage](#) 288
- [getBuild](#) 293
- [getConfigBoolean](#) 286
- [getConfigFloat](#) 287
- [getConfigInt](#) 287
- [getConfigValue](#) 286
- [getContentID](#) 293
- [getCurrentPageNumber](#) 291
- [getInitDone](#) 285
- [getInstancelD](#) 284
- [getInstanceName](#) 284
- [getMenuButtonPresent](#) 289
- [getPageContainerDim](#) 291
- [getPageLayoutData](#) 294
- [getPageNumberString](#) 291
- [getParameters](#) 294
- [getPluginParameter](#) 295
- [getSkinClassName](#) 290
- [getTargetPage](#) 292
- [getVersion](#) 292
- [goToPage](#) 292
- [gotoPageAndZoom](#) 296, 296
- [goToPageNumeric](#) 292
- [hideMenuToolTip](#) 294
- [init](#) 285
- [lastPage](#) 288
- [makeBoolean](#) 295
- [pressMenuButton](#) 289
- [previousPage](#) 288
- [printAPI](#) 284
- [registerExternalMenuButton](#) 290
- [registerExternalMenuButtonsFromContainer](#) 290
- [releaseMenuButton](#) 289
- [setFullScreenElement](#) 291
- [showAboutWindow](#) 288
- [showMenuToolTip](#) 293
- [showSearchDialog](#) 296
- [start](#) 283
- [testAPIListenersStart](#) 296
- [testAPIListenersStop](#) 297
- [togglePageIndex](#) 295
- [unregisterExternalMenuButton](#) 290
- [unregisterExternalMenuButtonsFromContainer](#) 290

Index

FSI Pages JS Parameters

- ForceLinkTip
 - ForceLinkTip 275
- General
 - adaptiveUISize 237
 - ButtonsFirstLastPage 240
 - cfg 236
 - debug 230
 - DemoToolTip 242
 - DemoURL 240
 - DemoURLTarget 241
 - dir 233
 - format 231
 - hideUI 237
 - HideUIInDemoMode 242
 - imageListLimit 233
 - imageListSort 233
 - imageListSortOrder 234
 - Index 240
 - language 236
 - ListFilterNegative 235
 - ListFilterPositive 234
 - ListTemplate 244
 - MaxZoom 238
 - MenuButtonOrder 239
 - OneClickZoom 238
 - PageDataTemplate 244
 - PageInput 243
 - PageInputEnterButton 243
 - Print 245
 - PrintEffects 245
 - PrintResolution 245
 - Save 246
 - SaveDocumentFile 247
 - SaveEffects 247
 - SaveResolution 246
 - skin 231
 - Zoom 238
- Layout/ Appearance
 - autoDoublePageMode 260
 - AutoFlipCropRect 257
 - BackCover 262
 - BackCoverImage 262
 - bendEffect 261
 - BlankBackCover 263
 - cropRect 257
 - cropValues 258
 - CustomPageNumbers 268
 - CustomPageNumbersFile 268
 - doublePageMode 260
 - dropShadow 255
 - dropShadowDistance 256
 - dropShadowOpacity 255
 - effects 258
 - emptyImages 263
 - FirstPageNumber 266
 - FrontCover 261
 - FrontCoverImage 262

- IdleAutoTurn [264](#)
- IdleAutoTurnDelay [265](#)
- IdleAutoTurnMaxPage [265](#)
- IdleAutoTurnMinPage [264](#)
- InitialPage [256](#)
- MousewheelNavigation [259](#)
- onePageInView [260](#)
- PageLayout [254](#), [254](#)
- PageNumbers [266](#)
- Ratio [256](#)
- RememberLastViewedPage [269](#)
- RememberLastViewedPageExpireAfter [269](#)
- removePages [264](#)
- RomanPageNumbersOffset [267](#)
- ThumbSize [259](#)
- UseRomanPageNumbersToPage [267](#)
- verticalLayout [259](#)
- Links [270](#)
 - DefaultJavaScriptTarget [275](#)
 - DefaultLinkTarget [274](#)
 - DefaultLinkTip [276](#)
 - DefaultLinkURL [273](#)
 - DefaultLinkUrlPrefix [274](#)
 - DefaultLinkUrlSuffix [274](#)
 - FollowLinks [271](#)
 - ForceJavaScriptTarget [275](#)
 - ForceLinkTarget [274](#)
 - ForceLinkURL [272](#)
 - ForceLinkUrlPrefix [273](#)
 - ForceLinkUrlSuffix [273](#)
 - linkRGBAAActive [271](#)
 - linkRGBABHover [270](#)
 - linkRGBANormal [270](#)
 - LinkTemplateData [272](#)
 - LinkTemplates [272](#)
- Search [248](#)
 - SearchAutoSelectFirstResult [250](#)
 - SearchAutoWildcard [249](#)
 - SearchContext [249](#)
 - SearchCustomURL [252](#)
 - SearchInput [248](#)
 - SearchParameters [252](#)
 - SearchResultClickAction [250](#)
 - SearchResultServerTemplate [252](#)
 - SearchSortResults [253](#)
 - SearchTextOnStart [251](#)
 - SearchThumbSize [251](#)
 - SearchType [248](#)
 - SearchUseMethodGet [253](#)

Index

FSI Pages JS Plugin Parameters

- Bookmarks [279](#)
 - PageNumbers [279](#)
 - PersistentStorage [280](#)
 - PersistentStorageExpiresAfter [280](#)
 - ShowIconsOnPages [279](#)
 - ThumbSize [279](#)
- Chapters [280](#)
 - indexDataFile [282](#)
 - Width [283](#)
- FullScreen [277](#)
- PagesThumbBar [277](#)
 - Autohide [278](#)
 - Height [278](#)
 - PageNumbers [277](#)
- Plugins [276](#)

FSI QuickZoom

- Callbacks
 - onConfigsReady [209](#)
 - onDestroy [209](#)
 - onInit [209](#)
 - onModifyPositionAndSize [210](#)
 - onStart [209](#)
 - onZoomEnd [209](#)
 - onZoomStart [210](#)
- Parameters
 - addCSSClass [194](#)
 - autoZoomDimension [196](#)
 - debug [190](#), [191](#)
 - disableByCSSClass [193](#)
 - enableByCSSClass [193](#)
 - headers [192](#)
 - imgSrcAttributeName [192](#)
 - inPlaceZoom [195](#)
 - magnification [195](#)
 - maxZoomWindowHeight [197](#)
 - maxZoomWindowWidth [197](#)
 - minZoomWindowHeight [198](#)
 - minZoomWindowWidth [197](#)
 - moveRangeCenterCorners [196](#)
 - pageMargin [199](#)
 - skipImageHeight [199](#)
 - skipImageWidth [198](#)

- useDevicePixelRatio 192
 - useTouch 191
 - zoomImageBorderWidth 199
 - zoomImageOffset 200
 - Public Methods
 - addImage 205
 - addListener 208
 - cancelZoom 205
 - destroy 205
 - dumpListeners 208
 - getBuild 206
 - getConfigValue 205
 - getImageCount 207
 - getInstanceID 206
 - getInstanceName 206
 - getParameters 207
 - getVersion 206
 - init 204
 - printAPI 204
 - removeImages 207
 - removeListener 208
 - scanForNewImages 207
 - testAPIListenersStart 208
 - testAPIListenersStop 208
 - traceConfigValue 206
- FSI Showcase JS
- Supported Devices 356
 - Usage 356
- FSI ThumbBar
- Callbacks
 - onAfterReplaceLabelTemplates 355
 - onBeforeReplaceLabelTemplates 354
 - onConfigsReady 354, 354
 - onDestroy 353
 - onFocus 353
 - onInit 353
 - onMetaData 354
 - onMouseEnter 355
 - onMouseLeave 355
 - onReplaceTemplateValue 354
 - onResize 354
 - onScrollEnd 355
 - onScrollStart 355
 - onSetScrollRange 355
 - onZoomEnd 353
 - onZoomReady 353
 - onZoomStart 353
 - How it works 312
 - Parameters
 - Alignment 331
 - autoElementSpacing 326, 326
 - autoResize 328
 - autoRotateSpeed 333
 - centerZoomedImage 331
 - cmdButtonSelector 336
 - cropRect 323
 - cropValues 323
 - debug 316, 316
 - depthFadeout 334
 - dir 317
 - effects 322
 - elementSpacing 325
 - elementWidth 324
 - enableZoom 329

- endlessScrolling 333
- format 321
- garbageCollectionSize 338
- headers 317
- imageListLimit 318
- imageListSort 318
- imageListSortOrder 319
- initialImage 328
- ListFilterNegative 320
- ListFilterPositive 319
- minelementSpacing 326
- minelementWidth 325
- overlays 321
- paddingBottom 327
- paddingTop 327
- PerspectiveAlignme nt 337
- placeholderImage 337
- placeholderPadEffe ct 338
- preloadCount 333
- presentationType 329
- quality 321
- renderer 320
- ScrollBar 331
- useTouchZoom 330
- vertical 328
- viewerSelector 336
- zoomMargin 330
- zoomShaderEndOp acity 335
- zoomShaderStartO pacity 334
- Public Methods
 - addImages 347
 - addListener 345
 - assignFSIViewer 345
 - buttonDown 346
 - buttonUp 346
 - changeConfig 347
 - changeDir 347
 - closeZoom 345
 - destroy 344
 - dumpListeners 345
 - firstImage 347
 - focusImage 345
 - getBuild 344
 - getConfigValue 348
 - getCurrentImageIn dex 348
 - getImageCount 348
 - getInitDone 344
 - getInstanceID 344, 395
 - getInstanceName 346
 - getParameters 348
 - getScrollPos 349
 - getVersion 344
 - init 343
 - isScrolling 349
 - lastImage 349
 - nextImage 349
 - nextPage 349
 - previousImage 349
 - previousPage 350
 - printAPI 344
 - registerButton 350

- removeAllImages [348](#)
 - removeImages [348](#)
 - removeListener [345](#)
 - setScrollPos [350](#)
 - startAutoRotate [350](#)
 - stopAutoRotate [350](#)
 - testAPIListenersStop [346](#), [346](#)
 - traceConfigValue [351](#)
 - unregisterButton [351](#)
 - zoomImage [345](#)
 - Supported Devices [309](#)
 - Usage [309](#)
- FSI TouchZoom
- Callbacks
 - onConfigsReady [185](#)
 - onDestroy [185](#)
 - onInit [185](#)
 - onZoomChanged [185](#)
 - Initialization [167](#)
 - Parameters
 - debug [171](#), [171](#)
 - disableByCSSClass [176](#)
 - enableByCSSClass [175](#)
 - imgSrcAttributeName [175](#)
 - loadingImage [174](#)
 - monitorPositions [172](#)
 - useDevicePixelRatio [172](#)
 - useTiledImages [173](#)
 - zoomPrecision [174](#)
 - Public Methods
 - addImage [178](#)
 - addListener [183](#)
 - destroy [180](#)
 - dumpListeners [184](#)
 - enable [182](#)
 - getBuild [181](#)
 - getConfigValue [179](#)
 - getImageCount [182](#)
 - getInstanceID [181](#)
 - getInstanceName [181](#)
 - getParameters [182](#)
 - getVersion [181](#)
 - init [180](#)
 - lockImage [182](#)
 - lockImageSourceImage [183](#)
 - lockUpdates [183](#)
 - printAPI [179](#)

- [removelImages 178, 178](#)
 - [removeListener 184](#)
 - [resetImage 183](#)
 - [scanForNewImages 177](#)
 - [setZoomPrecision 180](#)
 - [testAPIListenersStart 184](#)
 - [testAPIListenersStop 184](#)
 - [traceConfigValue 180](#)
 - [triggerRefresh 183](#)
 - [updateImagePositions 179](#)
 - [Supported Devices 165](#)
 - [Usage 165](#)
- FSI Viewer JS
- [Callbacks](#)
 - [on3DWorldChanged 162](#)
 - [onAfterReady 159](#)
 - [onAfterRegisterExternalButton 157](#)
 - [onAnimationComplete 156](#)
 - [onAnimationStart 156](#)
 - [onChangeConfig 156](#)
 - [onChangeImage 156](#)
 - [onClickDemoMode 162](#)
 - [onConfigsReady 153](#)
 - [onDataComplete 161](#)
 - [onDestroy 154](#)
 - [onEnterDemoMode 162](#)
 - [onExitDemoMode 162](#)
 - [onFullScreen 161](#)
 - [onHotspotEvent 163](#)
 - [onInit 154](#)
 - [onInit3D 163](#)
 - [onInitFailed 154](#)
 - [onInitMenu 160](#)
 - [onLanguageData 160](#)
 - [onMeasureChange 163](#)
 - [onMeasureEnd 164](#)
 - [onMeasureShow 164](#)

- onMeasureStart 164
- onMeasureUpdateRatio 164
- onMenuButtonClicked 158
- onMenuButtonEnabled 158
- onMenuButtonMouseDown 159
- onMenuButtonPressed 158
- onMenuButtonReleased 158
- onMenuButtonSetPressed 159
- onMenuDestroy 155
- onMenuEnabled 154
- onMenuReady 154
- onMouseModeChanged 160
- onProgress 157
- onReady 153
- onRegisterExternalMenuButtons 157
- onReset 159
- onResize 156
- onSkinChanged 157
- onStartDragging 160
- onStopDragging 161
- onViewChanged 161
- onZoomChanged 155
- onZoomChanging 155
- Conditional Configuration Options 28
 - Building Conditions 32
 - Cascaded Conditions 30
 - Conditions and Groups 30
- Configuration 20
 - Configuration Parameters Hierarchy 26
 - Debug Mode 20
 - Parameter Retrieving from FSI Server 35
 - XML Configuration Files 21
- Embedding at runtime 129
- How it works 14
- Index Structure 19
- Parameters
 - Implementation 38
- Public Methods 133
 - addListener 140
 - changeConfig 133
 - changeImage 134
 - clickMenuButton 145
 - debugEnabled 135
 - debugError 135
 - debugLog 135
 - debugWarn 135
 - destroy 139
 - dumpListeners 140
 - getBuild 140
 - getConfigValue 136
 - getHotspotViewString 143
 - getImagesTransparent 147
 - getInFullscreenMode 146
 - getInitDone 136
 - getInstanceID 139
 - getInstanceName 139
 - getMenuButtonPressed 144

- getMenuHeight 140
- getMouseMode 139
- getParameters 148
- getPluginParameter 149
- getSkinClassName 146
- getSpinFrames 147
- getSrcDim 147
- getVersion 140
- getViewString 142
- getVisibleImageRect 137
- getVisibleImageRectParam 138
- getVisibleImageURL 138
- getZoom 142
- getZoomFloat 138
- gotoHotspot 144
- gotoViewString 143
- hideMenuToolTip 148
- init 136
- makeBoolean 149
- pressMenuButton 144
- printAPI 135
- registerExternalMenuButton 145
- registerExternalMenuButtonsFromContainer 146
- releaseMenuButton 145
- removeListener 141
- resetView 141
- setFullScreenElement 147
- setMouseMode 139
- setZoom 142
- showAboutWindow 141
- showMenuButton 141
- showMenuToolTip 148
- spinToDegree 137
- spinToTarget 137
- start 134
- startAutoSpin 150
- stopAutoSpin 150
- testAPIListenersStart 149
- testAPIListenersStop 150
- traceConfigValue 136
- unregisterExternalMenuButton 145
- unregisterExternalMenuButtonsFromContainer 146
- updateSize 141
- Spin Videos 128
- Supported Devices 11
- Usage 11
 - Additional Buttons 18
 - Menu Bar 16
 - Mouse Modes 17
 - Navigator Window 19

J

JavaScript InterfaceFSI Pages JS JavaScript Interface

- Public Methods
 - getConfigString [287](#)
 - nextPage [288](#)
 - removeListener [287](#)

P

Parameter

- Camera
 - armAngleMeasureSetup [86](#)
 - armEndAngle [87](#)
 - armJointPosition [86](#)
 - armLength [86](#)
 - armStartAngle [87](#)
 - digitalCropFactor [78](#)
 - distanceToTableCenter [82](#)
 - focalLength [80](#)
 - heightAboveTable [84](#)
 - heightCamera [82](#)
 - heightTable [82](#)
 - position, targetPosition [80](#)
 - targetHeightOffset [83](#)
 - targetWidthOffset [83](#)
- Display Options
 - adaptiveUISize [68](#)
 - autoDisablePointerActions [70](#)
 - autoHideNav [64](#)
 - autoSpinInterval [65](#)
 - autoSpinSpeed [65](#)
 - backgroundColor [66](#)
 - desktopClickZoomScale [66](#)
 - documentZoom [69](#)
 - enableZoom [66](#)
 - hideUI [63](#)
 - inPlaceZoom [68](#)
 - loadExactPreviewImagesAfterResize [70](#)
 - maxZoom [70](#)
 - minInstanceSize [71](#)
 - mouseSensitivity [67](#)

- noNav 64
- pellets 67
- pelletsOpacity 68
- General
 - autoDestroy 58
 - cfg 42
 - debug 42
 - DemoToolTip 59
 - DemoURL 58
 - DemoURLTarget 59
 - dir 47
 - drawCube 55
 - drawGroundPlate 56
 - drawTable 55
 - easingSpin 53
 - easingZoom 53
 - effects 51
 - format 43
 - headers 42
 - HideUIInDemoMode 59
 - imageListLimit 48
 - imageListParameterFilterPositive 362, 363
 - imageListSort 48
 - imageListSortOrder 49
 - imagesources 47
 - initialMouseMode 57
 - initialView 52
 - initialViewPersistant 52
 - InvisibleLoadingPurposes 45
 - language 50
 - ListFilterNegative 50
 - ListFilterPositive 49
 - menuButtonOrder 57
 - navHeight 44
 - navWidth 44
 - NoSceneLoop 62
 - NoSetLoop 62
 - panLimits 53
 - preventImageTransparency 54
 - reverseSceneSets 62
 - ScenePreload 63
 - SceneSets 60
 - skin 45
 - spinDirectionImage 60
 - src 47
 - tableDiameter 56
 - urlLoadingAnimation 44
 - useDevicePixelRatio 54
- Global Hot Spot Parameter
 - decodeHTMLEntitiesInHotSpotTexts 77
 - enableHotspots 74
 - hotspotCallbackFunction 74
 - hotspotDotColor1 76
 - hotspotDotColor2 77
 - hotspotDotRadius 77
 - hotspotLineColor1 76
 - hotspotLineColor2 76

- Hot Spot
 - actionParameter 100
 - activeClass 104
 - cssClass 107
 - cssStyle 107
 - focusAngleX 103
 - focusAngleY 103
 - focusOnClick 101
 - focusRadius 103
 - horizontalMarkerPosition 94
 - horizontalMarkerSize 93
 - hoverClass 104
 - interactive 100
 - markerAngle 96
 - normalClass 103
 - perimeterAngle 96
 - perimeterAngleFadeOut 98
 - perimeterAngleFadeOutX 98
 - perimeterAngleRange 97
 - perimeterAngleRangeX 97
 - perimeterAngleX 96
 - perimeterImageWidth 99
 - perimeterZoom 99
 - rotateOnFocus 102
 - text 93
 - url 101
 - urlTarget 101
 - verticalMarkerPosition 95
 - verticalMarkerSize 94
 - x 92
 - y 92
 - z 92
 - zoomOnFocus 102
- Plugin
 - AutoSpin 116
 - AutoSpin_Button 117
 - AutoSpin_Interval 116
 - AutoSpin_preventClickZoomWhileSpinning 117
 - AutoSpin_Speed 116
 - FullScreen 113
 - maxZoom 114
 - Measure 120
 - Measure_BGColor 128
 - Measure_Decimals 125
 - Measure_ImageWidth 123
 - Measure_Initial 124
 - Measure_LineColor 126
 - Measure_Prefix 124
 - Measure_ShowAngle 126
 - Measure_showInAllMouseModes 125
 - Measure_ShowText 126
 - Measure_Suffix 124
 - Measure_TextBorder 127
 - Measure_TextColor 127
 - Measure_TextSize 128
 - MouseModes 118
 - MouseModes_MenuOffset 118
 - MouseModes_Mode 118
 - MouseModes_Sequence 119
 - plugins 112

Index

- Resize [113](#)
 - ZoomMeter [114](#), [114](#)
 - zoomMeter_color [114](#)
 - zoomMeter_decimals [115](#)
 - zoomMeter_srcRelative [115](#)
 - Preview Options
 - progressBarHAlign [73](#)
 - progressBarHeight [73](#)
 - progressBarVAlign [73](#)
 - progressBarWidth [72](#)
 - showPreviewWhileLoading [71](#)
 - showProgressbar [72](#)
 - spinPreviewWhileLoading [72](#)
 - Video
 - base [108](#)
 - captureFrames [109](#)
 - captureOffsetEnd [110](#)
 - captureOffsetStart [109](#)
 - frameOffset [112](#)
 - heightCorrectionFactor [111](#)
 - sceneSet [108](#)
 - source [107](#)
 - spinDirection [109](#)
 - widthCorrectionFactor [110](#)
 - xCorrectionFactor [111](#)
 - yCorrectionFactor [112](#)
 - virtualSpace
 - baseRotationX [88](#)
 - baseRotationY [88](#)
 - baseRotationZ [88](#)
 - cubelineWidth [88](#)
 - cubeSizeX [88](#)
 - cubeSizeY [88](#)
 - cubeSizeZ [88](#)
 - position [90](#)
 - rotationXRange [89](#)
 - rotationXSets [89](#)
 - rotationYRange [89](#)
 - rotationYScenes [90](#)
 - shiftX [90](#)
 - shiftY [90](#)
 - shiftZ [90](#)
- Presets
- Usage
 - Printing Pages [220](#)